

User Manual

Network Video Recorder

Please read this manual carefully before operating the unit and keep it for further reference

Notes

- Please read this user manual carefully to ensure that you can use the device correctly and safely.
- There may be several technically incorrect places or printing errors in this manual. The updates will be added into the new version of this manual. The contents of this manual are subject to change without notice.
- This device should be operated only from the type of power source indicated on the marking label. The voltage of the power must be verified before using the same. Kindly remove the cables from the power source if the device is not to be used for a long period of time.
- Do not install this device near any heat sources such as radiators, heat registers, stoves or other devices that produce heat.
- Do not install this device near water. Clean only with a dry cloth.
- Do not block any ventilation openings and ensure proper ventilation around the machine.
- Do not power off the device at normal recording condition.
- This machine is for indoor use only. Do not expose the machine in rain or moist environment. In case any solid or liquid get inside the machine's case, please turn off the device immediately and get it checked by a qualified technician.
- Do not try to repair the device by yourself without technical aid or approval.
- In this manual, the trademarks, product names, service names, company names, products that are not owned by our company are the properties of their respective owners.
- It is recommended to back up and clear the personal data stored in the device before the device is returned to us for repair or replacement except those data that are essential for purposes of repair or replacement. The device will be restored to the default factory settings and all personal data will be cleared after repair or replacement. Our company ensures that the customer's data is not made available to third parties if the device is exchanged.
- This manual is suitable for many models. All examples and pictures used in the manual are from one of the models for reference purpose.
- The local language versions of this manual will be provided to users in the corresponding regions and countries.

Disclaimer

- With regard to the product with internet access, the use of product shall be wholly at your own risks. Our company shall be irresponsible for abnormal operation, privacy leakage or other damages resulting from cyber attack, hacker attack, virus inspection, or other internet security risks; however, our company will provide timely technical support if necessary.
- Surveillance laws vary from country to country. Check all laws in your local region before using this product for surveillance purposes. We shall not take the responsibility for any consequences resulting from illegal operations. In the event of any conflicts between this manual and the applicable law, the later prevails.

- The storage of the personal data depends on the capacity of the storage devices the users use and all data stored in the device shall be handled by themselves. Our company shall not be responsible for the data loss.

Cybersecurity Recommendations

- Use a strong password. At least 8 characters or a combination of characters, numbers, and upper and lower case letters should be used in your password.
- Set the password expiration time and regularly change the passwords of your devices to ensure that only authorized users can access the system. (recommended time is 90 days).
- The system will automatically check the latest firmware version once a day. Once the latest version is checked, you'd better update it to ensure the system is current with the latest security patches and fixes.
- It is recommended to change the service default ports (like HTTP-80, HTTPS-443, etc.) to reduce the risk of outsiders being able to access.
- It is recommended to set the firewall of your router. But note that some important ports cannot be closed (like HTTP port, HTTPS port, Data Port).
- It is not recommended to expose the device to the public network. When it is necessary to be exposed to the public network, please set the external hardware firewall and the corresponding firewall policy.
- It is not recommended to use the v1 and v2 functions of SNMP.
- In order to enhance the security of WEB client access, please create a TLS certificate to enable HTTPS.
- Use black and white list to filter the IP address. This will prevent everyone, except those specified IP addresses from accessing the system.
- If you add multiple users, please limit functions of guest accounts.
- If you enable UPnP, it will automatically try to forward ports in your router or modem. It is really very convenient for users, but this will increase the risk of data leakage when the system automatically forwards ports. Disabling UPnP is recommended when the function is not used in real applications.
- Check the log. If you want to know whether your device has been accessed by unauthorized users or not, you can check the log. The system log will show you which IP addresses were used to log in your system and what was accessed.

Regulatory Information

FCC Information

1. FCC compliance

The products have been tested and found in compliance with the council FCC rules and regulations part 15 subpart B. These limits are designed to provide reasonable protection against harmful interference. This equipment generates uses and can radiate radio frequency energy and, if not installed and used in accordance with the instruction manual, may cause harmful interference to radio communication. However, there is no guarantee that interference will not occur in a particular installation. The user will be required to correct the interface at his own expense in case the harmful interference occurs.

2. FCC conditions:

Operation of this product is subject the following two conditions: (1) this device may not cause harmful interface, and (2) this device must accept any interference received, including interference that may cause undesired operation.

CE Information

 The products have been manufactured to comply with the following directives.
EMC Directive 2014/30/EU

RoHS

The products have been designed and manufactured in accordance with Directive EU RoHS Directive 2011/65/EU and its amendment Directive EU 2015/863 on the restriction of the use of certain hazardous substances in electrical and electronic equipment.



2012/19/EU (WEEE directive): The Directive on waste electrical and electronic equipment (WEEE Directive). To improve the environmental management of WEEE, the improvement of collection, treatment and recycling of electronics at the end of their life is essential. Therefore, the product marked with this symbol must be disposed of in a responsible manner.

Directive 94/62/EC: The Directive aims at the management of packaging and packaging waste and environmental protection. The packaging and packaging waste of the product in this manual refers to must be disposed of at designated collection points for proper recycling and environmental protection.

REACH(EC1907/2006): REACH concerns the Registration, Evaluation, Authorization and Restriction of Chemicals, which aims to ensure a high level of protection of human health and the environment through better and earlier identification of the intrinsic properties of chemical substances. The product in this manual refers to conforms to the rules and regulations of REACH. For more information of REACH, please refer to DG GROWTH or ECHA websites.

Table of Contents

1	Introduction	1
	1.1 Summary	1
	1.2 Features	1
	1.3 Front Panel Descriptions	5
	1.4 Rear Panel Descriptions	5
	1.5 Connections.....	9
2	Basic Operation Guide.....	12
	2.1 Startup & Shutdown	12
	2.1.1 Startup	12
	2.1.2 Shutdown.....	12
	2.2 Remote Controller.....	12
	2.3 Mouse Control.....	14
	2.4 Text-input Instruction	14
	2.5 Common Button Operation	15
3	Wizard & Main Interface	16
	3.1 Startup Wizard.....	16
	3.2 Main Interface	22
	3.2.1 Main Interface Introduction.....	22
	3.2.2 Setup Panel.....	25
	3.2.3 Main Functions.....	26
4	Camera Management.....	28
	4.1 Add/Edit Camera	28
	4.1.1 Add Camera.....	28
	4.1.2 Edit Camera.....	30
	4.2 Add/Edit Camera Group.....	32
	4.2.1 Add Camera Group.....	32
	4.2.2 Edit Camera Group.....	32
	4.2.3 IP Planning	32
5	Live View Introduction	34
	5.1 Live View Interface Introduction	34
	5.2 View Mode.....	35
	5.2.1 Preview By Display Mode.....	35
	5.2.2 Quick Sequence View.....	38
	5.2.3 Camera Group View In Sequence.....	38
	5.2.4 Scheme View In Sequence	39
	5.3 POS Settings	41
	5.4 Preview Image Configuration	44
	5.4.1 OSD Settings.....	44
	5.4.2 Image Settings	45
	5.4.3 Mask Settings	45
	5.4.4 Fisheye Settings.....	46
	5.4.5 Image Adjustment	46
6	PTZ.....	49

6.1 PTZ Control Interface Introduction	49
6.2 Preset Settings	54
6.3 Cruise Settings	54
6.4 Cruise Group Settings	55
6.5 Trace Settings	56
6.6 Task Settings	57
6.7 Smart Tracking	58
7 Record & Disk Management	61
7.1 Record Configuration	61
7.1.1 Mode Configuration	61
7.1.2 Schedule Settings	63
7.1.3 Advanced Configuration	66
7.2 Encode Parameters Settings	66
7.3 Record Mode	67
7.3.1 Manual Recording	67
7.3.2 Timing Recording	67
7.3.3 Motion Based Recording	67
7.3.4 Sensor Based Recording	67
7.3.5 AI Event Recording	67
7.4 Disk	68
7.4.1 Disk Management	68
7.4.2 Storage Mode Configuration	71
7.4.3 View Disk and S.M.A.R.T. Information	72
8 Playback & Backup	74
8.1 Instant Playback	74
8.2 Playback Interface Introduction	74
8.3 Smart Playback	79
8.3.1 Smart Playback Settings	79
8.3.2 Smart Playback Based on Motion Detection	80
8.3.3 Smart Playback by Face Search	81
8.3.4 Smart Search by License Plate	82
8.4 Record Search, Playback & Backup	83
8.4.1 Search, Playback & Backup by Time-sliced Image	83
8.4.2 Search, Playback & Backup by Time	85
8.4.3 Search, Playback & Backup by Event	86
8.4.4 Search & Playback by Tag	87
8.4.5 Image Management	87
8.4.6 View Backup Status	88
9 AI Event Management	89
9.1 Face Recognition	89
9.1.1 Face Detection Settings	89
9.1.2 Face Database Management	91
9.1.3 Face Recognition Settings	94
9.2 License Plate Recognition	96
9.2.1 License Plate Detection Settings	96
9.2.2 Plate Database Management	97
9.2.3 License Plate Recognition Settings	98

9.3 Line Crossing	99
9.4 Intrusion Detection	101
9.5 Abandoned/Missing Object Detection	102
9.6 Crowd Density Detection	102
9.7 Target Counting	103
9.8 Exception Detection	106
10 Intelligent Analytics	107
10.1 Target Detection View	107
10.1.1 Human Body/Vehicle Detection View	107
10.1.2 Face Detection/Match View	107
10.1.3 License Plate Detection/Recognition View	111
10.2 Smart Search	113
10.2.1 Face Search	113
10.2.2 Track Playback	118
10.2.3 Face Search by Snapshot	120
10.2.4 Human Body Search	121
10.2.5 Vehicle Search	121
10.2.6 Combination Search	123
10.3 View Statistical Information	123
10.4 Face Attendance	124
10.5 Face Check-In	126
10.6 Enabling AI Mode	127
11 General Event Management	128
11.1 Sensor Alarm	128
11.2 Motion Alarm	129
11.2.1 Motion Configuration	129
11.2.2 Motion Alarm Handling Configuration	130
11.3 Combination Alarm	131
11.4 Exception Alarm	131
11.4.1 IPC Offline Settings	131
11.4.2 Exception Alarm Settings	132
11.5 Alarm Event Notification	132
11.5.1 Alarm-out	132
11.5.2 E-mail	132
11.5.3 Display	133
11.5.4 Buzzer	133
11.5.5 Push Message	133
11.5.6 Audio	134
11.5.7 Light	136
11.5.8 Alarm Server	136
11.6 Manual Alarm	136
11.7 View Alarm Status	137
12 Account & Permission Management	138
12.1 Account Management	138
12.1.1 Add User	138
12.1.2 Edit User	139
12.2 User Login & Logout	141

12.3	Permission Management	141
12.3.1	Add Permission Group	141
12.3.2	Edit Permission Group	142
12.4	Black and White List	142
12.5	Preview On Logout	143
12.6	Network Security	143
12.7	Password Security	144
12.8	View Online User	144
13	Device Management	145
13.1	Network Configuration	145
13.1.1	TCP/IP Configuration	145
13.1.2	Port Configuration	147
13.1.3	PPPoE Configuration	150
13.1.4	DDNS Configuration	150
13.1.5	E-mail Configuration	153
13.1.6	UPnP Configuration	154
13.1.7	802.1X	155
13.1.8	NAT Configuration	155
13.1.9	FTP Configuration	155
13.1.10	SNMP	156
13.1.11	Cloud Upgrade	157
13.1.12	Platform Access	157
13.1.13	UPnP Report Access	158
13.1.14	ONVIF	159
13.1.15	Sub Stream Settings	159
13.1.16	View Network Status	159
13.2	Basic Configuration	160
13.2.1	Common Configuration	160
13.2.2	Date and Time Configuration	161
13.2.3	Recorder OSD Settings	161
13.2.4	PoE Power Management	161
13.3	Factory Default	162
13.4	Device Software Upgrade	162
13.5	Backup and Restore	163
13.6	Restart Automatically	163
13.7	View Log	163
13.8	View System Information	164
14	Remote Surveillance	165
14.1	Mobile Client Surveillance	165
14.2	Web LAN Access	165
14.3	Web WAN Access	166
14.4	Web Remote Control	167
14.4.1	Remote Preview	168
14.4.2	Remote Playback	172
14.4.3	Remote Search and Backup	173
14.4.4	Intelligent Analysis	173
14.4.5	Remote Configuration	173
Appendix A	FAQ	175

Appendix B Calculate Recording Capacity	182
Appendix C Compatible Device List	183
Appendix D Communication Port List	184
Appendix E Personal Data Collection Description	185
Appendix F Default Account List.....	186
Appendix G Command List	187

1 Introduction

1.1 Summary

Based on the most advanced SOC technology and embedded system in the field, this series of the NVR adopt the new designed human interface and support the smart management of the IP camera and the record search of slice. This series of the NVR which are powerful and easy to use are provided with excellent image quality and stable system. They are centralized monitoring management products with high performance and high quality specially designed for network video monitoring field.

This series of the NVR can be widely used to security system of banks at home and abroad, schools, intelligent mansions, traffic, environmental protection, supermarkets, petrol service stations, residential quarters and factories and so on.

1.2 Features

Basic Functions

- Support network device access including IP camera/dome and Onvif IP cameras
- Some NVRs support the H.265S/H.265+/ H.265 and H.264S/H.264+/ H.264 IP cameras
- Support standard ONVIF protocol
- Support dual stream recording of each camera
- Support IP cameras to be added quickly or manually
- Support collective or individual configuration of the cameras' OSD, video parameters, mask, motion and so on
- Support IPC's multiple smart detection access and linkage, such as scene change, video color cast detection, video blur detection, intrusion detection (region entrance/exiting detection), target counting, abandoned object detection, missing object detection, crowd density detection, face detection, license plate detection, smart tracking, etc.
- Support playback and backup
- Support multiple user permission groups including Administrator, Advanced and Ordinary which are the default permission groups of the system
- Support multiple users to be created, multiple web clients login by using one username at the same time and the user's permission control to be enabled or disabled
- Support multiple web clients login at the same time (depending on models)
- Support binding NVR to the account of the mobile APP

Live View

- Support 4K×2K/1920×1080/1280×1024 HDMI and 1920×1080/1280×1024 VGA high definition synchronous display
- Support multi-screen modes such as 1/4/6/8/9/13/16/25/36
- Some models support face capture view, face match view, license plate recognition view, human/motor vehicle /non-motor vehicle view
- Support auto adjustment of the camera's image display proportion
- Support audio monitoring of the camera to be enabled or disabled

- Support manual snapshot of the preview camera
- Support the sequence of the preview cameras to be adjusted
- Support display mode to be added and saved and the saved modes can be called directly
- Support quick tool bar operation of the preview window
- Support camera group view and scheme view in sequence, quick sequence view and dwell time setting
- Support motion detection and video mask
- Support multiple popular P.T.Z. control protocol and setup of the preset and cruise
- Support direct mouse control of the IP dome including rotating, zoom, focusing and so on
- Support single camera image to be zoomed by sliding the scroll wheel of the mouse
- Support any area of the image to be zoomed in to a maximum of 16 times of the current size
- Support image and lens adjustment (only available for some cameras)
- Support quick camera adding in the camera window of the live preview interface
- The live camera sequence of the web client will keep consistent with that of the NVR after adjusting the live camera sequence of the NVR, but the live camera sequence of the NVR will not be changed if that of the web client is changed

Disk Management

- The NVRs with the 3U case can add a maximum of 16 SATA HDDs; a maximum of 8 SATA HDDs with the 2U case, a maximum of 4 SATA HDDs with the 1.5U case, a maximum of 2 SATA HDDs with the 1U case and a maximum of 1 SATA HDD with the small 1U case
- Each SATA interface of the NVR supports the HDDs with max 10TB storage capacity. Some models may support max 12TB storage capacity per HDD
- Some of the NVRs support record to be backed up by e-SATA HDD
- Support hot swap
- Support disk group configuration and management and each camera can be added into different disk groups with different storage capacity
- Support disk information and disk working status viewing
- Support batch formatting of the disks

Record Configuration

- Support main stream and sub stream recording at the same time and batch or single configuration of the record stream
- Support customization and auto record modes
- Support schedule recording, sensor alarm recording and motion detection recording, etc
- Support smart playback by drawing line, quadrilateral and rectangle.
- Support schedule recording and event recording setting with different record streams
- Support record schedule setting and recycle recording
- Support pre recording and delay recording configuration of the event recording

Record Playback

- Support time scale operation in quick playback and the playback date and time can be set randomly by scrolling the mouse; the time interval of the time scale can be zoomed
- Support record searching by time slice/time/event/tag

- Support smart playback by drawing grid, line or quadrilateral and vehicle smart playback (some models also support smart playback by face)
- Support time view and camera view in searching by time slice mode
- Support time slice searching by month, by day, by hour and by minute and time slice to be displayed with camera thumbnail
- Support a maximum of 16 cameras to be searched by time
- Support event searching by manual/motion/sensor/intelligent events
- Support tag searching by the manual added tags
- Support instant playback of the selected camera in the live preview interface
- Support a maximum of 16 synchronous playback cameras
- Support acceleration(maximum 32 times of the normal speed), deceleration (minimum 1/32 times of the normal speed) and 30s' addition or reduction to current playing time

Record Backup

- Support record to be backed up through USB (U disk, mobile HDD) or e-SATA interface
- Support record to be backed up by time/event/image searching
- Support record cutting for backing up when playing back
- Support multiple backup tasks in background and backup status viewing

Event Management

- Support alarm schedule setting
- Support enabling or disabling of the motion detection, external sensor alarm input, combination alarm, intelligence alarm and exception alarms including IP address conflict alarm, disk IO error alarm, disk full alarm, no disk alarm, illegal access alarm, network disconnection alarm, IPC offline alarm and so on, alarm linkage configuration supportable
- Support IPC offline alarm linkage configuration of PTZ, snap, pop-up video, etc.
- Support event notification modes of alarm-out, pop-up video, pop-up message box, buzzer, e-mail and so on
- The snapped images can be attached into the e-mail when alarm linkage is triggered
- Support alarm status view of alarm-in, alarm-out, motion detection and exception alarm
- Support alarm to be triggered and cleared manually
- Support system auto reboot when exception happens
- Support alarm linkage based on face detection, vehicle detection and license plate recognition
- Some models support face match alarm

Face Function (available for some models)

- Support adding 5000 face pictures to the face database (some models support adding 10,000 face pictures to the face database)
- Support face capture and face match
- Support image search by image, track playback and database management
- Support face attendance and face check in
- Support face information statistics
- Support face match alarm

LPR Function

- Support 50,000 license plate register (some models only support 1,000 license plate register)
- Support license plate detection, match and search
- Support vehicle information statistics
- Support license plate match alarm

Network Functions

- Support TCP/IP and PPPoE, DHCP, DNS, DDNS, UPnP, NTP, SMTP protocol and so on
- Support black and white list function and the IP address/IP segment/MAC address can be allowed or blocked.
- Support multiple browsers including IE8/9/10/11, Firefox, Opera, Chrome (available only for the versions lower than 45) and Safari in MAC system
- Support remote achievement, configuration, import and export of the NVR parameters and other system maintenance operations including remote upgrading and system restart
- Support remote camera configuration of the NVR including video parameters, image quality and so on
- Support remote searching, playback and backup of the NVR
- Support manual alarm to be triggered and cleared remotely
- The auto-focusing camera can be adjusted through web client (support zoom in/out, but one key focus is not currently supported)
- Support NVMS or other platform management software to access the NVR and manage it
- Support NAT function and QRCode scanning by mobile phones and tablets
- Support mobile surveillance by phones or tablets with iOS or Android OS
- Support NVR to be accessed remotely through telnet and the telnet function can be enabled or disabled
- If one camera recording is enabled or disabled manually through web client, it will be simultaneously enabled or disabled in the NVR
- Support direct jumping from NVR web client to IPC web client
- The installation mode and display mode of the fisheye camera can be set via Web client

Other Functions

- The NVR can be controlled and operated by the buttons on the front panel, the remote controller and the mouse
- Setting interfaces can be switched to one another conveniently by clicking the main menus on the top of the setting interfaces
- Support NVR information viewing including basic, camera status, alarm status, record status, network status, disk and backup status
- Support factory restoring, import and export of the system configuration, log view and export and local upgrading by USB mobile device
- Support auto recognition of the displayer's resolution
- You can click the right mouse button at any interface to go back to the upper interface
- You can click the middle mouse button at any interface to go to the live view interface
- The display language and video format of the NVR will not be changed and the system logs will be reserved if you reset the NVR to factory default

- Press and hold the right mouse button for 5 seconds in any interface to switch the output to VGA and the NVR will display the video at the lowest resolution which the NVR supports





1.3 Front Panel Descriptions

The following descriptions are for reference only.

Type I:

Name	Descriptions
REC	When recording, the light is blue
Net	When access to network , the light is blue
Power	Power indicator, when connection , the light is blue
Fn	No function temporarily

Type II:

Name	Descriptions
Power	Power Indicator, when connected, the light is blue
HDD	The light turns blue when reading/writing HDD
Net	The light turns blue when it is able to access the network
Backup	The light turns blue when backing up files and data
Play	The light turns blue when playing video
REC	Power Indicator, when connected, the light is blue
AUDIO +/-	1. Adjust audio 2. Increase the value in setup
P.T.Z / -	1. Enter PTZ mode 2. Decrease the value in setup
MENU	Enter Menu in live
INFO	Check the information of the device
BACKUP	Enter backup mode in live
SEARCH	Enter search mode in live
Exit	Exit the current interface
	Manually record
	Play/Pause
	Speed down
	Speed up
1-9	Input digital number and select camera
0/--	Input number 0, the number above 10
Direction Key	Change direction
Multi-Screen Switch	Change the screen mode
Enter	Confirm selection
USB	To connect external USB device like USB mouse or USB

1.4 Rear Panel Descriptions

Here we only take a part of real panels for example to introduce their interfaces and

connections. The interfaces and locations of the interfaces are only for references. Please take the real object as the standard.

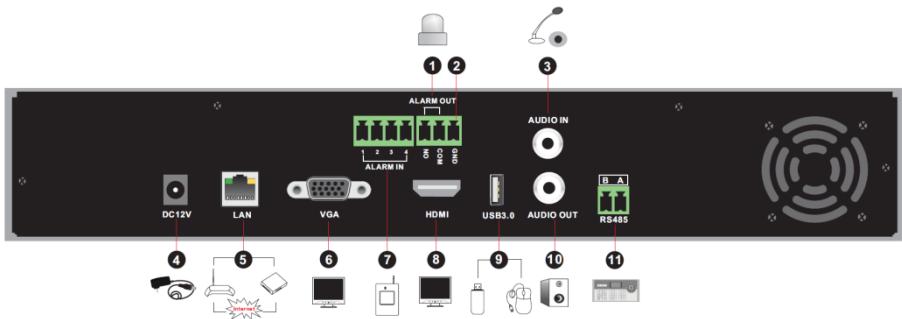

No.	Name	Descriptions
1	ALARM OUT	Relay output; connect to external alarm
2	GND	Grounding
3	AUDIO IN	Audio input; connect to audio input device, like microphone, pickup, etc
4	DC12V	DC12V power input
5	LAN	Network port
6	VGA	Connect to monitor
7	ALARM IN	Alarm inputs for connecting sensors
8	HDMI	Connect to high definition display device
9	USB	Connect USB storage device or USB mouse
10	AUDIO OUT	Audio output; connect to sound box
11	RS485	Connect to keyboard. A is TX+, B is TX-

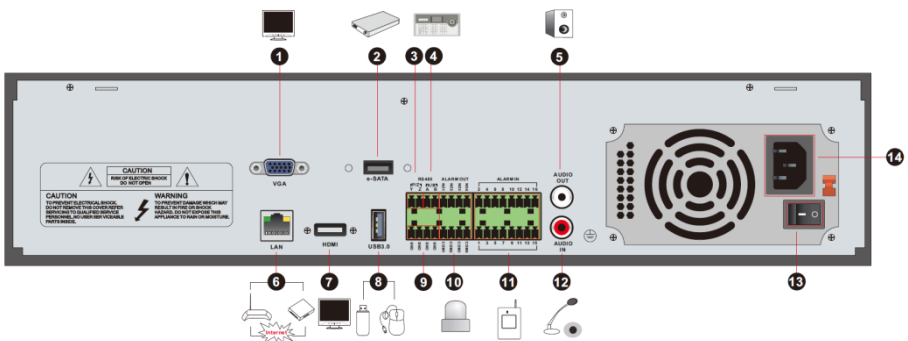

No.	Name	Descriptions
1	VGA	Connect to monitor
2	e-SATA	Connect to HDD with e-SATA interface
3	RS485 Y/Z interface	Connectors for speed dome. Y is TX+, Z is TX-

No.	Name	Descriptions
		(This interface of some models is unavailable.)
4	RS485 A/B interface	Connect to a keyboard. A is TX+; B is TX-
5	AUDIO OUT	Audio output; connect to sound box
6	LAN	Network port
7	HDMI	Connect to high definition display device
8	USB	Connect USB storage device or USB mouse
9	GND	Grounding
10	ALARM OUT	Relay output; connect to external alarm
11	ALARM IN	Alarm inputs for connecting sensors
12	AUDIO IN	Audio input; connect to audio input device, like microphone, pickup, etc
13	Power Switch	Press the switch to turn on/off the NVR
14	Power Supply	Power supply interface

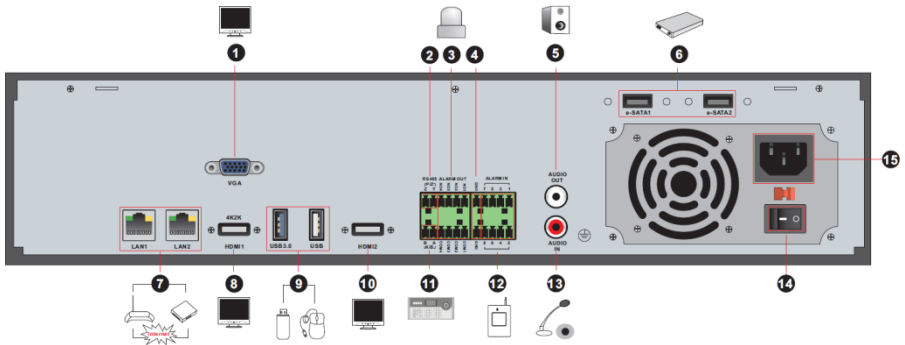

No.	Name	Descriptions
1	VGA	Connect to monitor
2	RS485 Y/Z interface	Connect to speed dome. Y is TX+, Z is TX- (This interface of some models is unavailable.)
3	ALARM OUT	Relay output; connect to external alarm
4	GND	Grounding
5	AUDIO OUT	Audio output
6	e-SATA1/ e-SATA2	Connect to HDD with e-SATA interface
7	LAN1/LAN2	Network port
8	HDMI1	Connect to 4K×2K high definition display device
9	USB3.0/USB	USB3.0 and USB 2.0 interface, connect USB storage device or USB mouse
10	HDMI2	Connect to 1920×1080 high definition display device. Connect to monitor as an AUX output channel by channel. Only video display, no menu show
11	RS485 A/B interface	Connect to a keyboard. A is TX+; B is TX-
12	ALARM IN	Alarm inputs for connecting sensors

No.	Name	Descriptions
13	AUDIO IN	Audio input
14	Power Switch	Press the switch to turn on/off the NVR
15	Power Supply	Power supply interface

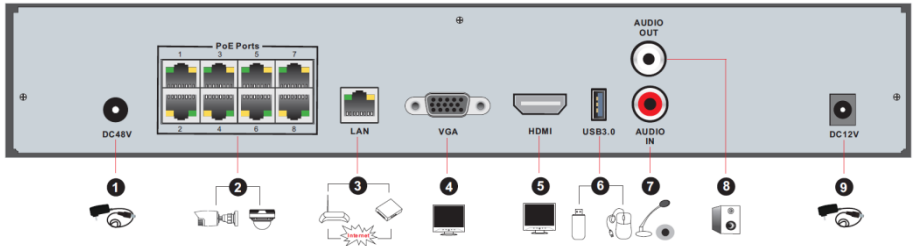

No.	Name	Descriptions
1	Power Supply	DC48V power supply interface
2	PoE port	8 PoE network ports; connect to 8 PoE IP cameras
3	LAN	Network port
4	VGA	Connect to monitor
5	HDMI	Connect to 1920×1080 high definition display device
6	USB3.0	USB3.0 interface, connect USB storage device or USB mouse
7	AUDIO IN	Audio input; connect to audio input device, like microphone, pickup, etc
8	AUDIO OUT	Audio output; connect to sound box
9	Power Supply	DC12V power supply interface

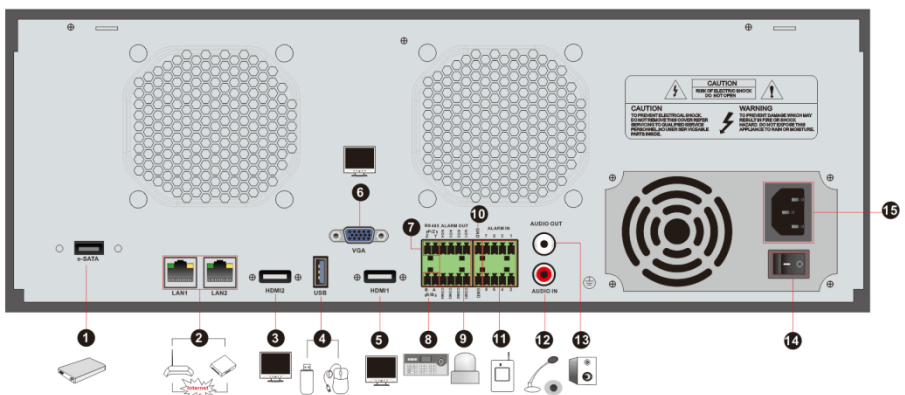

No.	Name	Descriptions
-----	------	--------------

No.	Name	Descriptions
1	e-SATA	Connect to HDD with e-SATA interface
2	LAN1/LAN2	Network port
3	HDMI2	Connect to 1920×1080 high definition display device. Connect to monitor as an AUX output channel by channel. Only video display, no menu show
4	USB	USB interface, connect USB storage device or USB mouse
5	HDMI1	Connect to 4K×2K high definition display device
6	VGA	Connect to monitor
7	RS485 Y/Z interface	Connect to speed dome. Y is TX+, Z is TX- (This interface of some models is unavailable.)
8	RS485 A/B interface	Connect to keyboard. A is TX+; B is TX-
9	ALARM OUT	Relay output; connect to external alarm
10	GND	Grounding
11	ALARM IN	Alarm inputs for connecting sensors
12	AUDIO IN	Audio input; connect to audio input device, like microphone, pickup, etc
13	AUDIO OUT	Audio output; connect to sound box
14	Power Switch	Press the switch to turn on/off the NVR
15	Power Supply	Power supply interface

1.5 Connections

● Video Connections

Video Output: Supports VGA/HDMI video output. You can connect to monitor through these video output interfaces simultaneously or independently.

● Audio Connections

Audio Input: Connect to microphone, pickup, etc.

Audio Output: Connect to headphone, sound box or other audio output devices.

● Alarm Connections

Some models may not support this function. Take 16 CH alarm inputs and 1 CH alarm output for example.

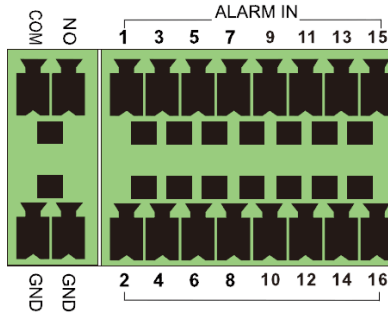

Alarm Input:

Alarm IN 1~16 are 16 CH alarm input interfaces. There are no type requirements for sensors. NO type and NC type are both available.

The way to connect sensor and the device is as shown below:

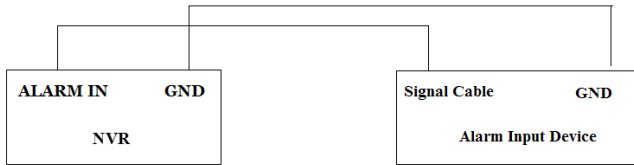

The alarm input is an open/closed relay. If the input is not an open/closed relay, please refer to the following connection diagram:

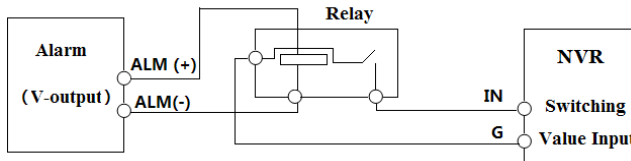

Alarm Output:

The way to connect alarm output device:

Pull out the green terminal blocks and loosen the screws in the alarm-out port. Then insert the signal wires of the alarm output devices into the port of NO and COM separately. Finally, tighten the screws. Provided that the external alarm output devices need power supply, you can connect the power supply as per the following figures.

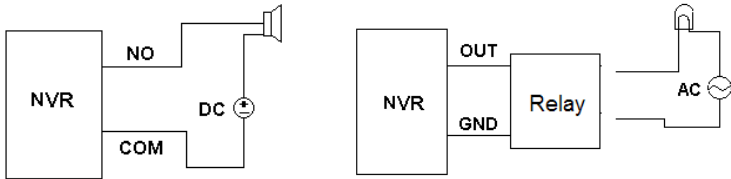

- **RS485 Connection**

There are two types of RS485 interfaces:

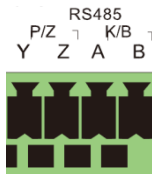

(Type 1)



(Type 2)

Type 1: The P/Z interfaces are unavailable temporarily. K/B interfaces are used to connect keyboard.

Type 2: The RS485 interfaces are used to connect keyboard. A is TX+; B is TX-.

2 Basic Operation Guide

2.1 Startup & Shutdown

Please make sure all the connections are done properly before you power on the unit. Proper startup and shutdown are crucial to extending the life of your device.

2.1.1 Startup

- ① Connect the output display device to the VGA/HDMI interface of the NVR.
- ② Connect with the mouse and power. The device will boot and the power LED would turn blue.
- ③ After you read the privacy statement, a WIZARD window will pop up (you should select the display language the first time you use the NVR). Refer to [3.1 Startup Wizard](#) for details.

2.1.2 Shutdown

You can power off the device by using remote controller or mouse.

By remote controller:

- ① Press the Power button. This will take you to a shutdown window. The unit will power off after a while by clicking the “OK” button.
- ② Disconnect the power.

By mouse:

- ① Click Start→Shutdown to pop up the Shutdown window. Select “Shutdown” in the window. The unit will power off after a while by clicking the “OK” button.
- ② Disconnect the power.

2.2 Remote Controller

- ① It uses two AAA size batteries.
- ② Open the battery cover of the remote controller.
- ③ Place batteries. Please take care the polarity (+ and -).
- ④ Replace the battery cover.

Key points to check in case the remote doesn't work.

1. Check batteries polarity.
2. Check the remaining charge in the batteries.
3. Check IR controller sensor for any masking.

If it still doesn't work, please change a new remote controller to try, or contact your dealers. You can just turn the IR sensor of the remote controller towards the IR receiver of the NVR to control it when you are controlling multiple devices by remote controller.

There are two kinds of remote controller. The interface of remote controller is shown as below.

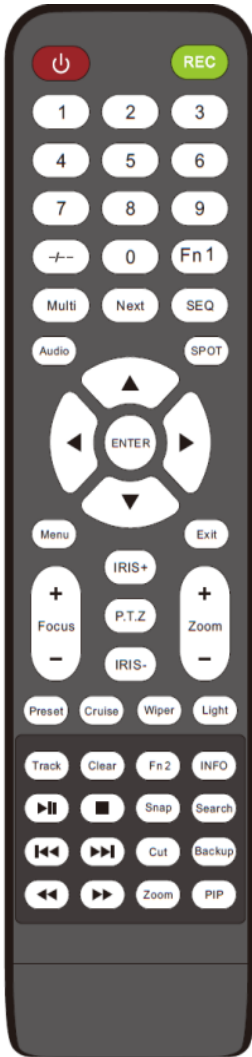

Button	Function
Power Button	Switch off—to stop the device
Record Button	To start recording
-/-- /0-9	Input number or choose camera
Fn1 Button	Unavailable temporarily
Multi Button	To choose multi screen display mode
Next Button	To switch the live image
SEQ	To go to sequence view mode
Audio	To enable audio output in live mode
Switch	No function temporarily
Direction button	To move cursor in setup or pan/title PTZ
Enter Button	To confirm the choice or setup
Menu Button	To go to menu
Exit Button	To exit the current interface
Focus/IRIS/Zoom/PTZ	To control PTZ camera
Preset Button	To enter into preset setting in PTZ mode
Cruise Button	To go to cruise setting in PTZ mode
Track Button	No track function temporarily
Wiper Button	No function temporarily
Light Button	No function temporarily
Clear Button	No function temporarily
Fn2 Button	No function temporarily
Info Button	Get information about the device
	To control playback. Play(Pause)/Stop/Previous Frame/Next Frame/Speed Down/Speed Up
Snap Button	To take snapshots manually
Search Button	To go to search mode
Cut Button	No function temporarily
Backup Button	To go to backup mode
Zoom Button	To zoom in the images
PIP Button	No function temporarily

Note:

You shall press P.T.Z button to enter PTZ setting mode, choose a channel and press P.T.Z button again to hide the P.T.Z control panel. Then you can press preset, cruise, track, wiper or light button to enable the relevant function.



Button	Function
REC	Record manually
Search	To enter search mode
MEUN	To enter menu
Exit	To exit the current interface
ENTER	To confirm the choice or setup
Direction button	To move cursor in setup
ZOOM	To zoom in
PIP	No function temporarily
	To control playback. Play(Pause)/Next Frame/Speed Up/Stop/Previous Frame/Speed Down
Multi	To choose multi screen display mode
Next	To switch the live image
SEQ	To go to sequence view mode
INFO	Get information about the device

2.3 Mouse Control

➤ Mouse control in Live Display & Playback interface

In the live display & playback interface, double click on any camera window to show the window in single screen mode; double click the window again to restore it to the previous size.

In the live display & playback interface, if the interfaces display in full screen, move the mouse to the bottom of the interface to pop up a tool bar. The tool bar will disappear automatically after you move the mouse away from it for some time; move the mouse to the right side of the interface to pop up a panel and the panel will disappear automatically after you move the mouse away from it.

➤ Mouse control in text-input

Move the mouse to the text-input box and then click the box. The input keyboard will pop up automatically.

Note: Mouse is the default tool for all operations unless an exception as indicated.

2.4 Text-input Instruction

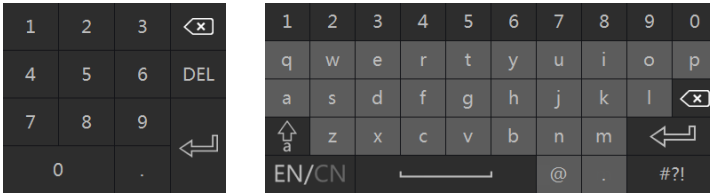

The system includes two input boxes. Refer to the above pictures. The left box is the number input box and the right box is the input box which provides inputs of numbers, letters and punctuation characters. The introductions of keys on the input boxes are shown below.



Button	Meaning	Button	Meaning
	Backspace key		Switch key of punctuation character
	Delete Key		Enter key
	Switch key between upper and lower letter		Space key
	Switch key of language		

2.5 Common Button Operation

Button	Meaning
	Click it to show the menu list.
	Click it to change the sequence of the list.
	Click it to change the camera displaying mode.
	Click it to close the current interface.
	Click it to go to the earliest date of camera recording.
	Click it to go to the latest date of camera recording.

3 Wizard & Main Interface

3.1 Startup Wizard

The disk icons will be shown on the top of the startup interface. You can view the number and status of each disk quickly and conveniently through these icons (: no disk; : unavailable disk; : RW available disk).

You can quickly configure the DVR by wizard setup to make the DVR work normally. You must configure the wizard if you start the DVR for the first time (or click “Skip” to cancel the wizard next time). Maybe different versions have different wizard steps. The following wizard steps are for reference only.

- ① Choose the language and locality as needed if it is the first time for you to use the wizard and then read the privacy statement, checkmark “*I have read and agree*” and click “OK”.
- ② **Date and Time Configuration.** The date and time of the system need to be set up if you use the wizard for the first time. Refer to the following figure. Set the time zone, system time, date format, time format and video format. The DST will be enabled by default if the time zone selected includes DST. Click “Next” to continue.

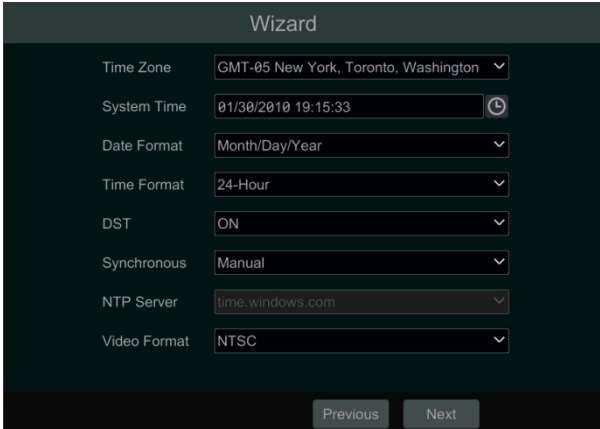

The screenshot shows a 'Wizard' configuration window with the following settings:

Field	Value
Time Zone	GMT-05 New York, Toronto, Washington
System Time	01/30/2010 19:15:33
Date Format	Month/Day/Year
Time Format	24-Hour
DST	ON
Synchronous	Manual
NTP Server	time.windows.com
Video Format	NTSC

At the bottom of the window, there are two buttons: 'Previous' and 'Next'.

- ③ **System Login.** Set your own password when you use the wizard for the first time (the default username of the system is *admin*); select the login username and enter the corresponding password next time.

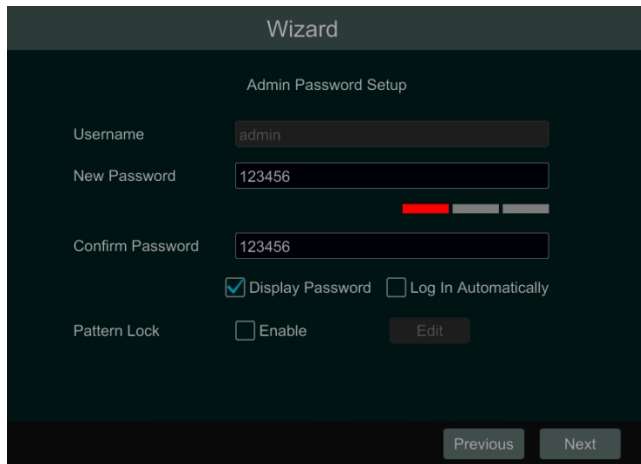

The screenshot shows the 'Wizard' interface for 'Admin Password Setup'. It includes the following fields and options:

- Username:** admin
- New Password:** 123456 (with a strength indicator bar below it)
- Confirm Password:** 123456
- Display Password
- Log In Automatically
- Pattern Lock:** Enable

At the bottom right, there are 'Previous' and 'Next' buttons.

Enable pattern lock and click “Edit” to set the pattern lock.

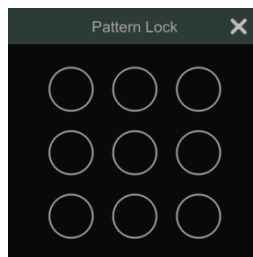

Click “Next” to set questions and answers for password security of admin. If you forget the password, please refer to Q4 in [Appendix A FAQ](#) for details.

Click “Next” to continue.

④ **Disk Settings.** You can view the disk number, disk capacity of the NVR and serial number, R&W status of the disk. Click “Format” to format the disk. Click “Next” to continue. Then click “Wizard Setup”.

⑤ **Network Settings.** Check “Obtain an IP address automatically” and “Obtain DNS automatically” to get the IP address and DNS automatically (the DHCP function of the router in the same LAN should also be enabled), or manually enter them. Enter the HTTP port, RTSP port and Server port (please see [13.1.2 Port Configuration](#) for details). Click “Next” to continue.

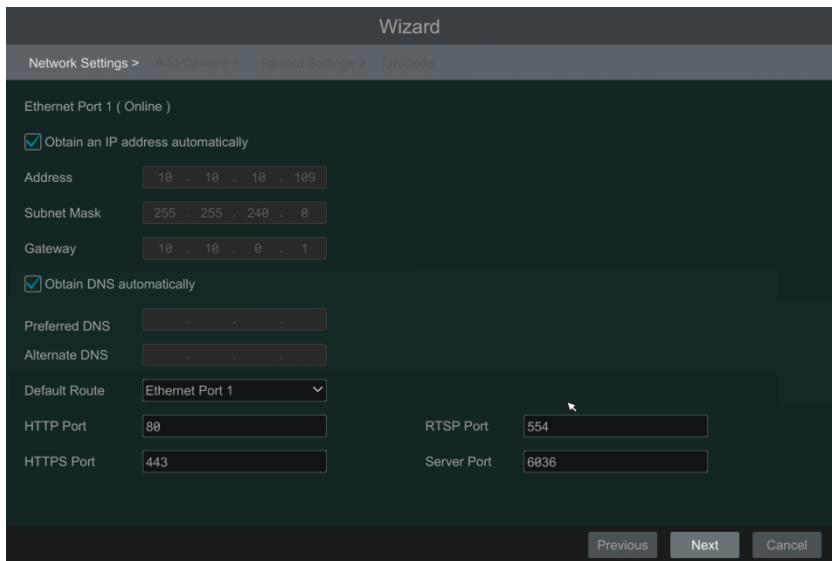

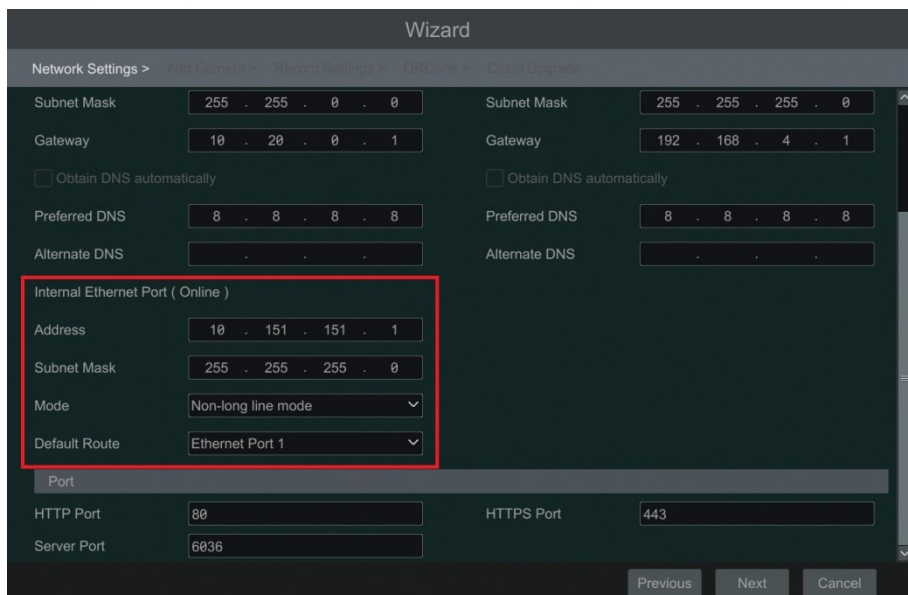

Note:

➤ If you use the NVR with the PoE network ports, the online state of the internal Ethernet port will be shown on the interface. Refer to the picture below. Please refer to [13.1.1 TCP/IP Configuration](#) for detail introduction of the internal Ethernet port.

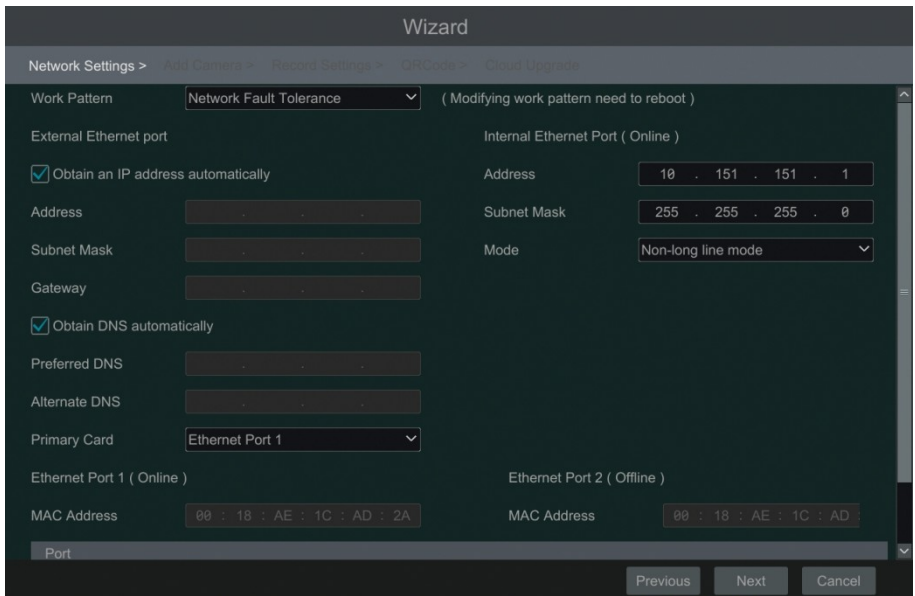
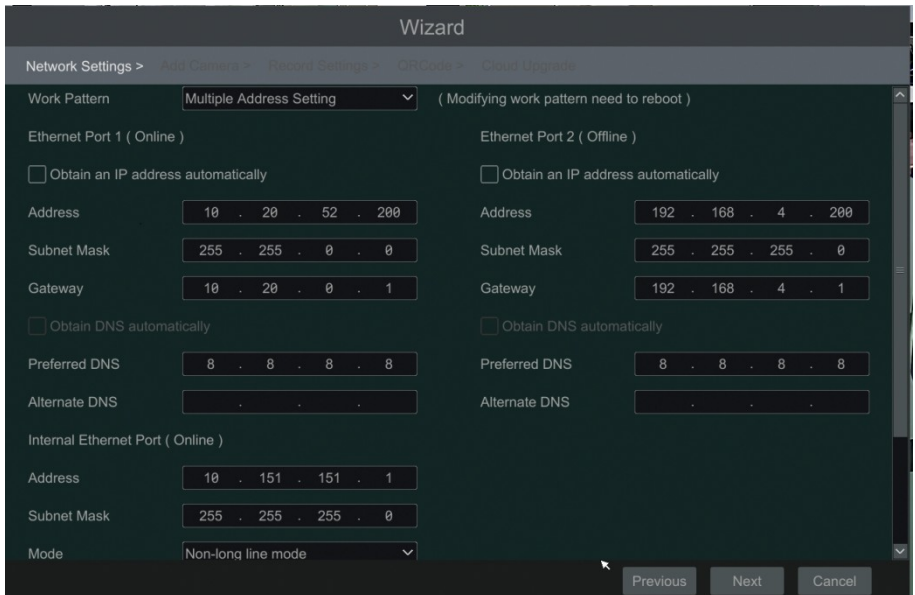

- If the NVR has two network ports or above, you can select the network work pattern as required. Network Fault Tolerance and Multiple Address Setting are available. Refer to the pictures below. Please refer to [13.1.1 TCP/IP Configuration](#) for more detailed information.



⑥ **Add Camera.** Click “Refresh” to refresh the list of online IP cameras which are in the same local network with NVR and then click  to add the searched camera. Click “Add All” to add all the cameras in the list. Click  to delete the added camera. Click “Delete All” to delete all the added cameras.

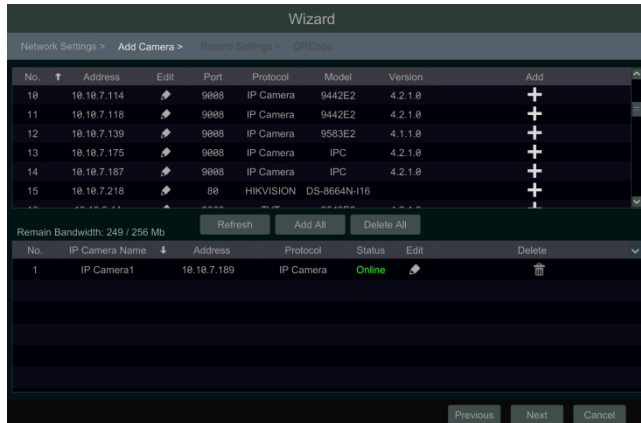

Click  to edit the searched IP camera as shown on the below left. Enter the new IP address, subnet mask, gateway, username and the password of the camera. Click “OK” to save the settings.

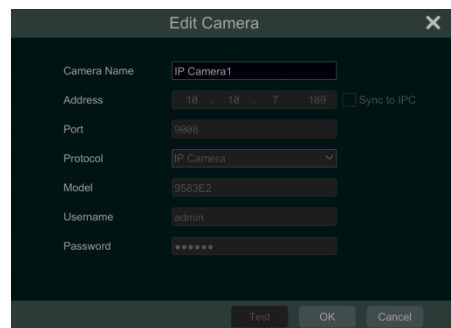
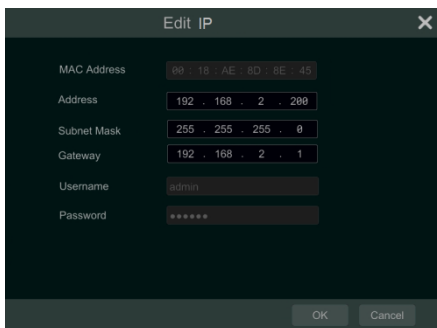

Click  to edit the added camera as shown on the above right. Enter the new camera name, IP address, port, username and the password of the camera. You can check “Sync to IPC” to modify the IP address of the IPC via different network segments for being in the same network segment with the NVR. Then click “Test” to test the connection. Click “OK” to save the settings. You can change the IP camera name only when the added camera is online. Click “Next” to continue.

Tips : Please skip Step ⑦ and ⑧ if the NVR do not support RAID function.

⑦ **Disk Mode.** Click “Enable RAID” to enable the RAID function. Click “Next” to continue.

⑧ **Create an array.** Set the array name and select array type which including RAID0, RAID1, RAID5, RAID6 and RAID10. The global hot spares and array capacity can also be viewed here. See [7.4 Disk](#) for details. Click “Next” to continue.

⑨ **Record Settings.** Two record modes are available: auto and customization.

Auto: Select one auto mode in the interface as shown below and then click the “Next” to save the settings. Click “Advanced” to self-define record mode. See [7.1.1 Mode Configuration](#) for details.

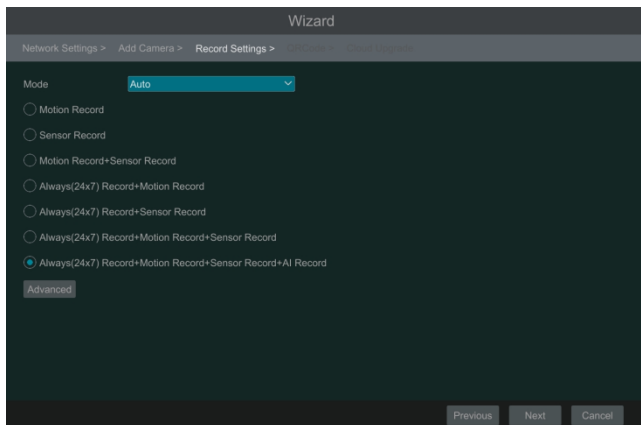

Customization: Set the “Sensor Record”, “Motion Record”, “AI Record”, “POS Record” and “Schedule Record” of each camera. Click “OK” to save the settings. See [7.1.1 Mode Configuration](#) for details.

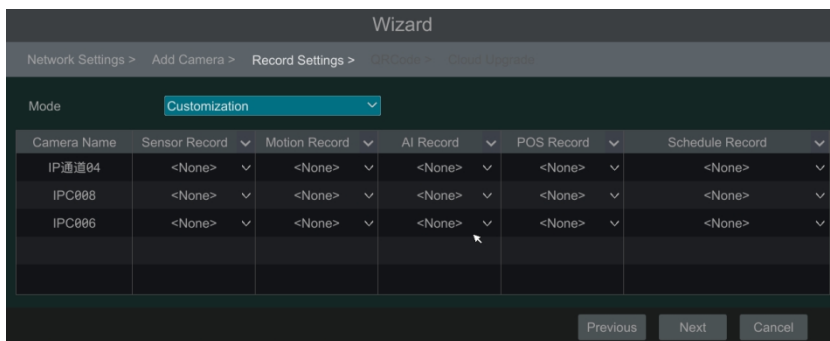

⑩ **QRCode.** Enable the NAT or NAT2.0 function in the interface or set it in the network configuration after exiting the wizard (please refer to [13.1.8 NAT Configuration](#) for details). You can scan the QRCode through mobile client which is installed in the mobile phone or tablet PC to log in the mobile client instantly. Please refer to [14.1 Mobile Client Surveillance](#) for details. Click “OK” to save the settings.

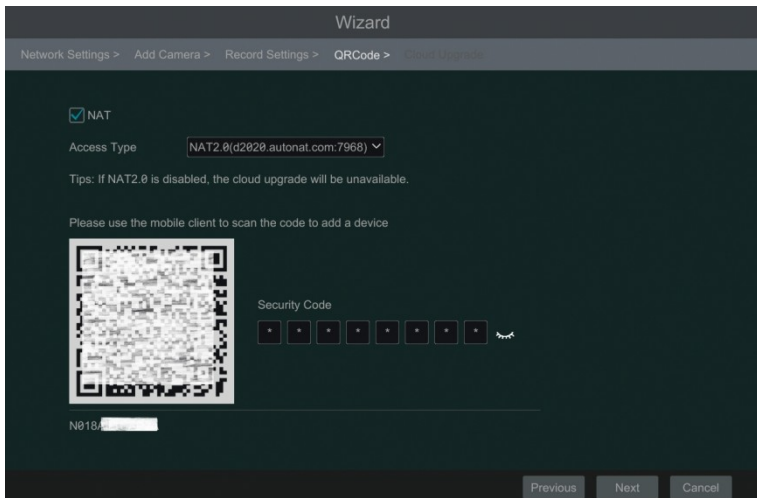

⑪ **Cloud Upgrade.** Enable “Cloud Upgrade” and then click “OK” to save. If this function is enabled, you can get the latest version from the cloud server. Please refer to [13.1.11 Cloud Upgrade](#) for details.

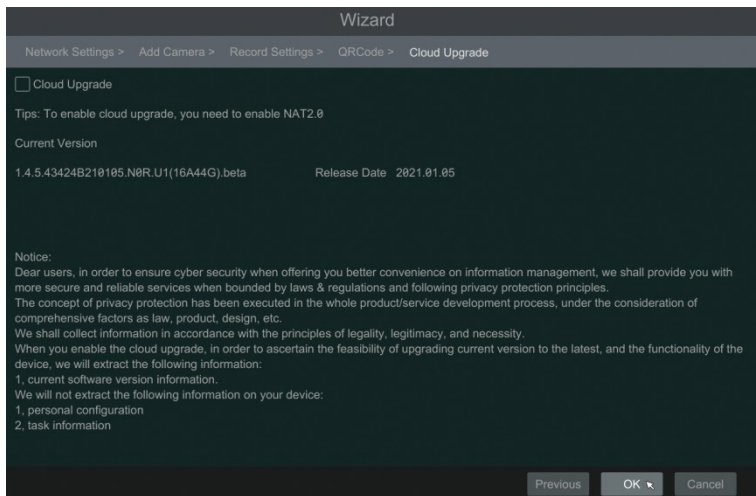

3.2 Main Interface

3.2.1 Main Interface Introduction

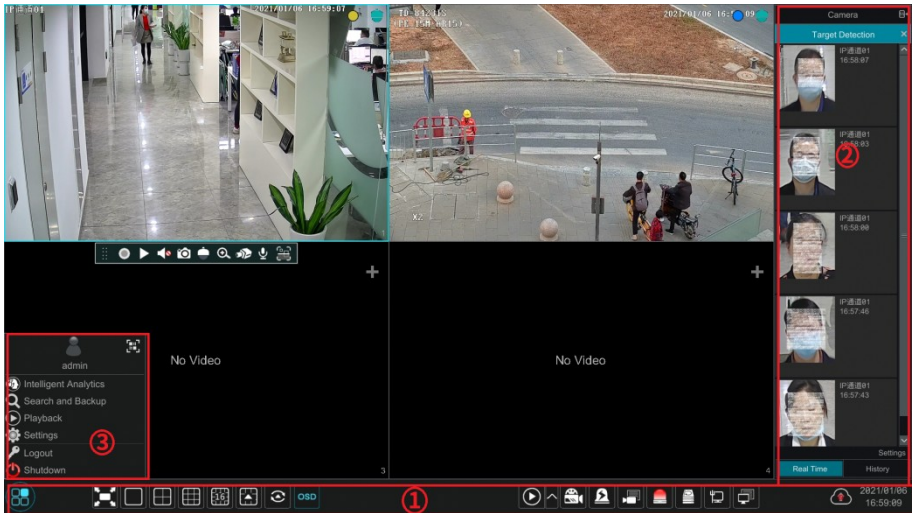

The buttons in area ① are introduced in the table below.

Button	Meaning
	Start button. Click it to pop up area ③.
	Full screen button. Click it to show full screen; click it again to exit the full screen.
	Screen mode button.
	Dwell button (see 5.2.2 Quick Sequence View and 5.2.4 Scheme View In Sequence for details).
	Click it to enable OSD; click again to disable OSD.
	Click to set the default playback time before starting instant playback (8.1 Instant Playback) or going to the playback interface for playback operations (8.2 Playback Interface Introduction); click to go to the playback interface. For instance, if you choose “5 minutes ago” as the default playback time, you can playback the record from the past five minutes.
	Manual record button. Click it to enable/disable record.
	Manual alarm button. Click it to trigger or clear the alarm-out manually in the popup window.
	Record status button. Click it to view the record status.
	Alarm status button. Click it to view the alarm status.
	Disk status button. Click it to view the disk status and RAID status.
	Network status button. Click it to view the network status.
	Information button. Click it to view system information.

Button	Meaning
	Click this button to enable cloud upgrade.

Note: Different models may have different buttons on the live view interface. See the following picture. All pictures in this manual are for reference only; the real product shall prevail.

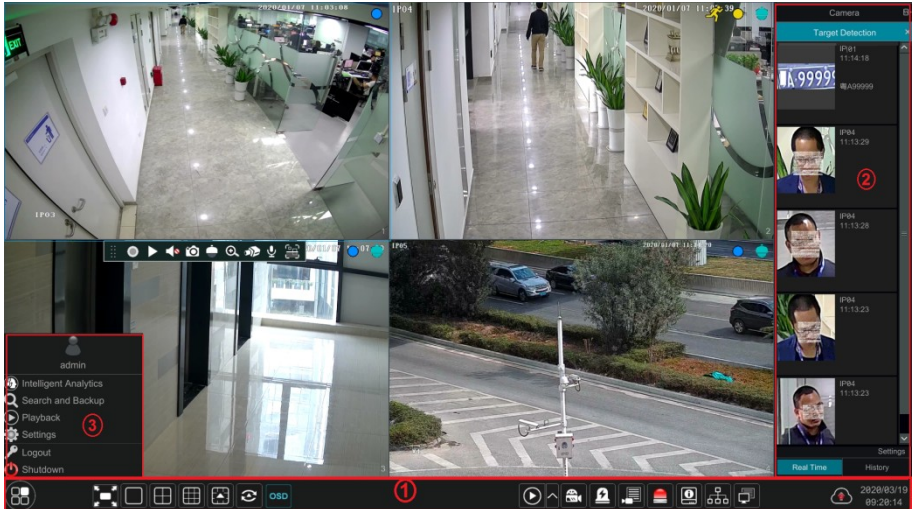

Introduction of area ②:

Area ② is hidden by default. Move the cursor to the right to reveal this area. Click “Camera” to view all the added cameras in the camera list. Select one camera window on the left side of the interface and then double click one camera in the list to preview the camera image in the selected window.

Click  on the top right corner and then select “Single Channel Sequences” to view all the added groups in the group list; click one group in the list to view all the added cameras in the group (refer to [4.2 Add/Edit Camera Group](#) for detail configuration of the camera group). Select one camera window on the left side of the interface and then double click one group in the group list to preview the cameras’ images one by one in the selected window.

Click  on the top right corner and then select “Customize Display Modes” to view all the display modes in the display mode list (refer to [5.2.1 Preview by Display Mode](#) for detail configuration of the display mode). Double click one display mode in the list to switch to the display mode for previewing.

Click  on the top right corner and then select “Target Detection” to go to target detection interface. This tab will show the captured human, vehicles, license plates and face images. (This function is only available for some models).

Introduction of area ③:

Icon / Button	Meaning
	It shows the current login user. Click the QR code icon to view the QR code and security code. User can quickly add the NVR to the server list of the mobile APP by scanning this QR code.
	Click it to go to the intelligent analytics interface.
	Click it to go to record search and backup interface, see 8.4 Record Search, Playback & Backup for details.
	Click it to go to playback interface (click on the tool bar at the bottom of the live preview interface to set the default playback time), see 8.2 Playback Interface Introduction for details.
	Click it to pop up the setup panel, see 3.2.2 Setup Panel for details.
	Click it to log out the system.
	Click it and then select “Logout”, “Reboot” or “Shutdown” in the popup window.

3.2.2 Setup Panel

Click Start→Settings to bring up the setup panel as shown below.

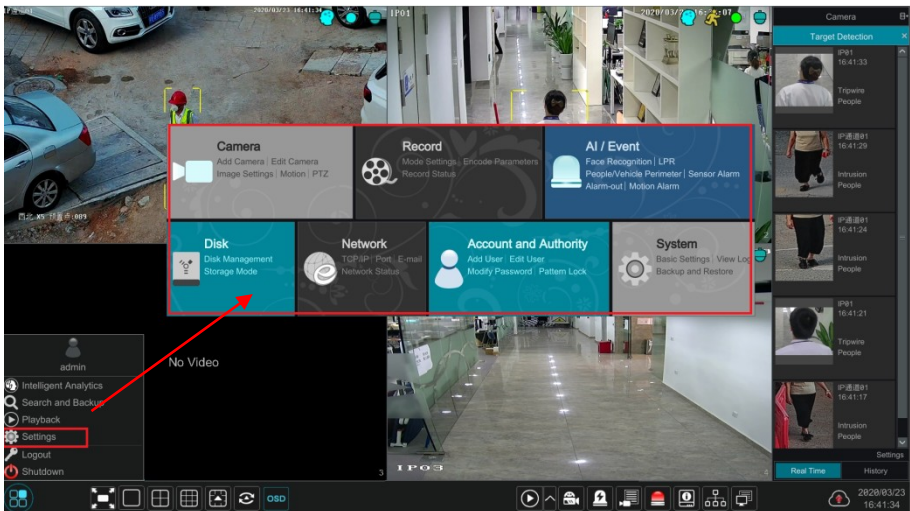

The setup panel includes seven modules. Each module provides some function entries with links for convenient operation.

Here we take **Camera** module as an example. The **Camera** module provides convenient links

such as “Add Camera”, “Edit Camera”, “Image Settings”, “Motion” and “PTZ”. Click **Camera** to go to the camera management interface as shown below.

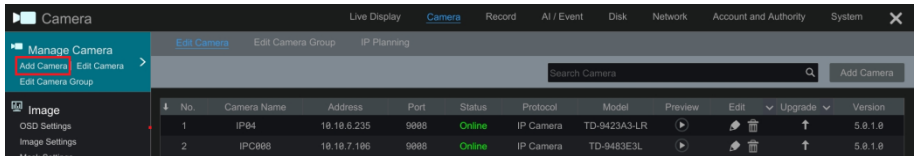

There are some function items on the left side of the camera management interface. Click each item to go to corresponding interface or window. For instance, click “Add Camera” to pop up the window as shown below.

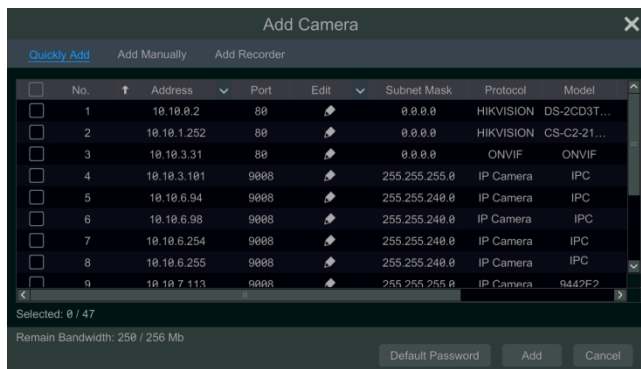

Click the main menus on the top of the camera management interface to go to corresponding interfaces. Refer to the picture below. For instance, you can go to system setup interface by clicking “System” tag.



3.2.3 Main Functions

➤ Camera

The module covers the functions such as **Camera Management** (see [Chapter 4 Camera Management](#) for details), **Image Settings** (see [5.4 Preview Image Configuration](#) for details), **Motion** (see [11.2 Motion Alarm](#) for details), and **PTZ** (see [Chapter 6 PTZ](#) for details) and so on.

➤ Record

The module covers the functions such as **Encode Parameters** and **Record Schedule** and so on. Please see [Chapter 7 Record & Disk Management](#) for details.

➤ **AI/Event**

The module covers the functions such as *Smart Event*, *Combination Alarm*, *Exception*, *Sensor and Motion Alarm Handling* and *Alarm Out Settings*. Please see [Chapter 9 AI Event Management](#) and [Chapter 11 General Event Management](#) for details.

➤ **Disk**

The module covers the functions such as *Disk Management*, *Storage Mode* and *Disk Information* and so on. Please see [Chapter 7 Record & Disk Management](#) for details.

➤ **Network**

The module covers the functions such as *TCP/IP*, *DDNS*, *Port*, *E-mail* and *Network Status* and so on. Please see [13.1 Network Configuration](#) for details.

➤ **Account and Authority**

The module covers the functions such as *Account Management* (see [12.1 Account Management](#) for details) and *Permission Management* (see [12.3 Permission Management](#) for details) and so on.

➤ **System**

The module covers the functions such as *Basic Configuration* (see [13.2 Basic Configuration](#) for details), *Device Information* (see [13.8 View System Information](#) for details), *Log Information* (see [13.7 View Log](#) for details) and *Configuration File Import & Export* (see [13.5 Backup and Restore](#) for details) and so on.

4 Camera Management

4.1 Add/Edit Camera

4.1.1 Add Camera

The network of the NVR should be set before adding IP camera (see [13.1.1 TCP/IP Configuration](#) for details).

Refer to the pictures below. Click **Add Camera** in the setup panel or  in the top right corner of the preview window to pop up the “Add Camera” window as shown below. You can quickly add or add the IP camera manually.

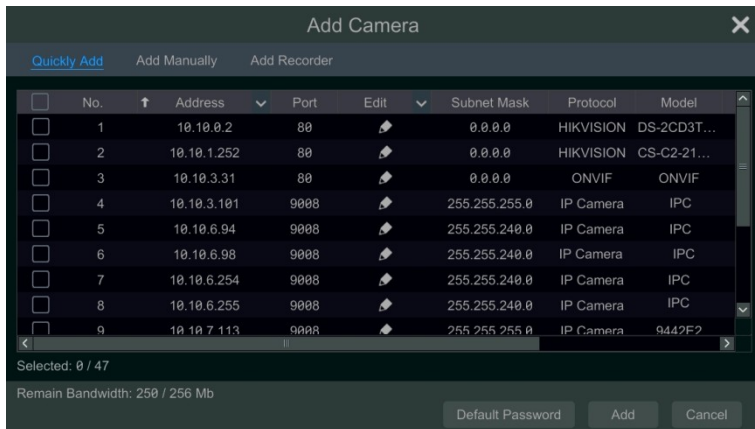
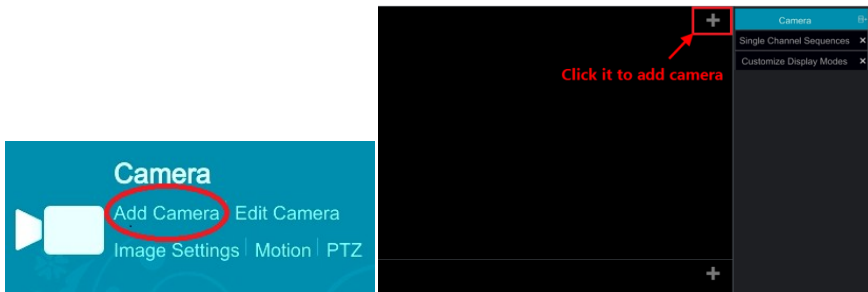

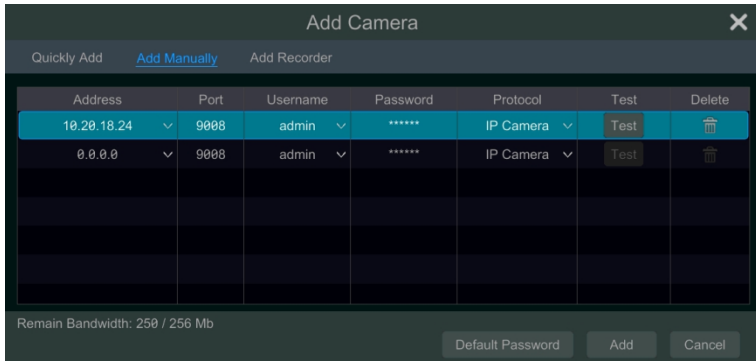

➤ Quickly Add

Check the cameras and then click “Add” to add cameras. Click  to edit the camera’s IP address, username and password and so on. Click “Default Password” to set the default username and password of each camera.



➤ **Add Manually**

Enter the IPv4/IPv6 address or domain name (click  in the IP address column to pop up the IPv4/IPv6/domain name input window), port, username and password of the camera and then select the protocol. Click “Test” and then click the “Add” button (you can input one camera’s information or above such as IP address, username and password before clicking the “Add” button). Click  to delete the camera. Click “Default Password” to set the default username and password of each camera.

Note: Some models may not support this function.

Click Start→Settings→System→Basic→General Settings to check “Enable Add IPC by Zero Operation”. If the NVR has unoccupied channels, it can add IPC without any operation by restarting.

➤ **Add Recorder**

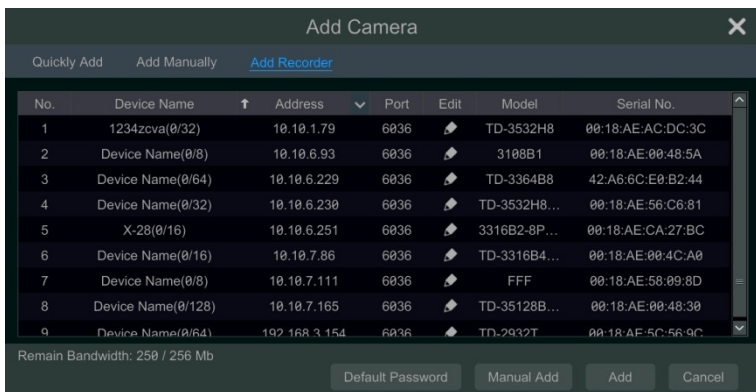





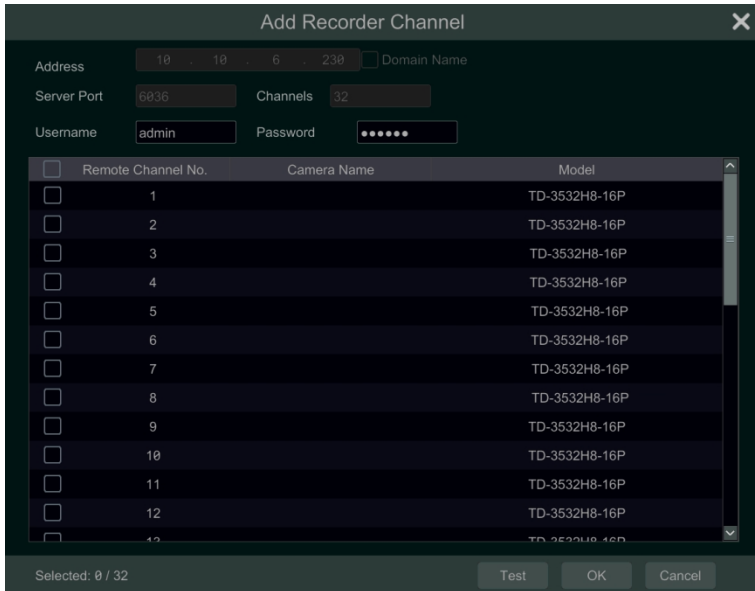

- **Quickly Add** : Select the searched NVR/DVR and the click “Add” to add NVR in the same local network.

- **Manually Add :** Click “Manual Add” and then enter the IP address or domain name, port, username and password of the NVR/DVR. Check the added remote channel number and click “Test”. Then click “OK” to return to the previous interface.



Note: Only the local NVR has unoccupied channels, may the IPC of other NVR/DVR in the same local network be added. And the added IPC supports previewing and recording.

4.1.2 Edit Camera

Click “Edit Camera” in the setup panel to go to the interface as shown below. Click  to view the live image of the camera in the popup window. Click  to edit the camera (see *Add camera* in [3.1 Startup Wizard](#) for details). Click  to delete the camera. Click  in the “Edit” header line and then click “Modify IPC Password” to pop up a window(check the IPCs in the window, set the new password and then click “OK”; only the online IPCs’ passwords can be modified and a batch of IPCs’ passwords can be modified at the same time). Click  to upgrade an online IPC (or click  in the “Upgrade” header line and then click “IPC Batch Upgrade” to upgrade a batch of IPCs), select the device which stores the upgrade file in the “Device Name” item of the popup window and the upgrade file in the list(you should select the upgrade IPC model in the window if a batch of IPCs’ passwords need to be modified) and then click “Upgrade” to start upgrading(the IPC will restart automatically after the upgrade is completed successfully).

No.	Camera Name	Address	Port	Status	Protocol	Model	Preview	Edit	Upgrade	Version
1	IP Camera1	10.10.7.189	9988	Online	IP Camera	9583E2				4.1.0.0

Note:

If you use the NVR with the PoE network ports, the IP cameras (with PoE function) which are directly connected to the PoE port of the NVR will be displayed automatically in the camera list. Refer to the picture below. The IP camera which occupies the PoE resource has a prefix shown before its camera name. The prefix consists of PoE plus PoE port number. The IP camera which connects to the PoE port cannot be deleted from the camera list manually.

No.	Camera Name	Address	Port	Status	Protocol	Model	Preview	Edit	Upgrade	Version
1	[POE3]IP Camera1	10.151.151.20	80	Online	ONVIF	xxx				3.4.2
2	IP Camera2	192.168.12.40	80	Online	ONVIF	xxx				3.4.2
3	IP Camera3	192.168.12.152	80	Online	ONVIF	xxx				3.4.2
4	IP Camera4	192.168.12.41	80	Online	ONVIF	xxx				3.4.2
5	IP Camera5	192.168.12.153	80	Offline	ONVIF	xxx				3.4.2
6	IP Camera6	192.168.12.154	80	Online	ONVIF	xxx				3.4.2
7	IP Camera7	192.168.12.155	80	Online	ONVIF	xxx				3.4.2
8	IP Camera8	192.168.12.156	80	Online	ONVIF	xxx				3.4.2
9	IP Camera9	192.168.12.157	80	Online	ONVIF	xxx				3.4.2
10	[POE1]IP Camera10	192.168.12.158	80	Online	ONVIF	xxx				3.4.2

IP Camera Max Number:
Remain Bandwidth: 108 /120 Mb

- The IP camera directly connected to the PoE port of the NVR through private protocol will be shown automatically in the camera list.
- One of the two conditions must be met if the IP camera which is directly connected to the PoE port of the NVR through ONVIF protocol should be shown automatically in the camera list.
 - ✓ The IP camera which is directly connected to the PoE port is in the same network segment with the internal Ethernet port.
 - ✓ The DHCP (obtain an IP address automatically) of the IP camera which is directly connected to the PoE port is enabled.

If the IP camera which is connected to the PoE port cannot be displayed automatically in the camera list, please refer to Q6 in [Appendix A FAQ](#) for details.

4.2 Add/Edit Camera Group

4.2.1 Add Camera Group

Click “Edit Camera Group” in the above interface to go to the interface as shown below.



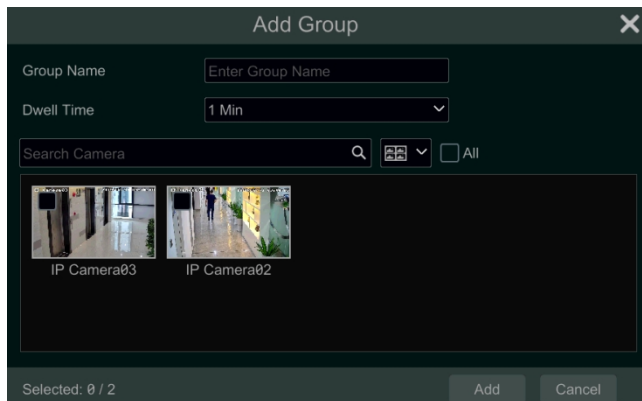

Click “Add Group” to pop up the window as shown below. Set the group name and dwell time (the dwell time of the camera group sequence view) in the window. Check the cameras and then click “Add” to add group. Click  to view the cameras in the group after adding group.

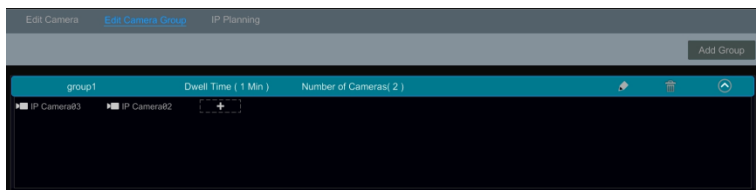

4.2.2 Edit Camera Group



Click  to modify the group information such as group name and dwell time. Click  to delete the group. Click  to add cameras to the group.



4.2.3 IP Planning

Some models may not support this function.

Click “IP Planning” to go to the interface as shown below. This function supports searching

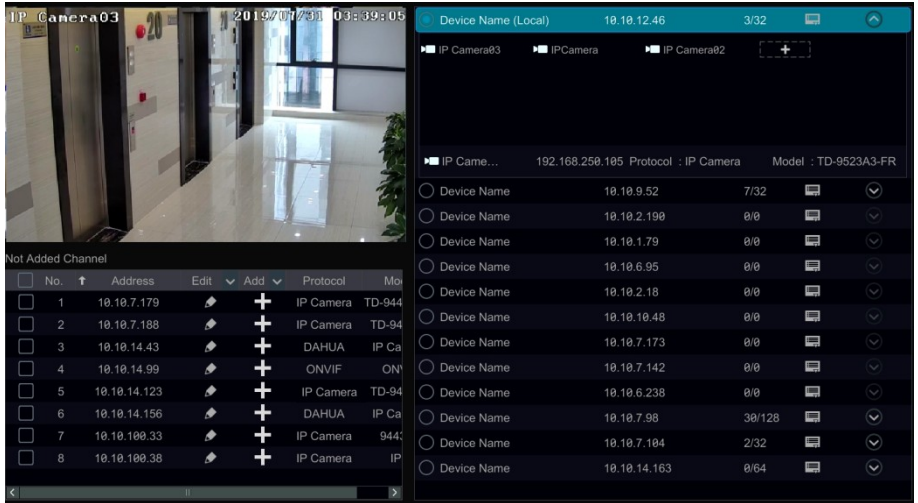
other NVRs/DVRs that is in the same local network as the local NVR. The user may add the IPC of other NVRs/DVRs into the unoccupied channels of the local NVR.



Click  to edit the IP address, user name or password and other information of the NVRs.
 Click  behind the “Add” button to add the IPC selected and the user may edit the IP address, user name or password by clicking  behind the “Edit” button.





5 Live View Introduction

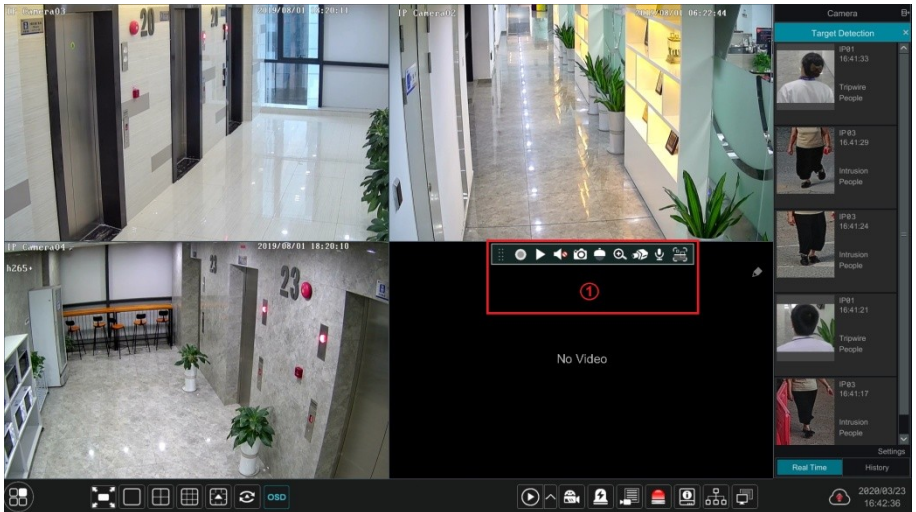





5.1 Live View Interface Introduction



You should add a camera first after logging on to the system (see 4.1.1 [Add Camera](#) for details). Refer to the interface as shown below, drag one camera in the preview window to another window for camera window exchanging. Click  button and then you can view the record symbols. The record symbols with different colors in the live preview window refer to different record types when recording: green stands for manual record, red stands for sensor based record, yellow stands for motion based record, blue stands for schedule record and cyan stands for intelligence record.



Click the preview window to show the tool bar as shown in area ①; right click the preview window to show the menu list. The tool bar and menu list are introduced in the table below.

Button	Menu List	Meaning
	--	Move tool. Click it to move the tool bar anywhere.
	Manually Record On	Click it to start recording.
	Instant Playback	Click  to playback the record; click “Instant Playback” to select or self-define the instant playback time. See 8.1 Instant Playback for details.
	Enable Audio	Click it to enable audio. You can listen to the camera audio by enabling audio.
--	Original Proportions/ Overspread window	Click it to select the display proportion of the window.

Button	Menu List	Meaning
	Snapshot	Click it to pop up the snap window. Click “Save” in the window to save the image. Click “Export” to export the image.
	PTZ Control	Click it to go to PTZ control interface. See Chapter 6 PTZ for details.
	Zoom In	Click it to go to single channel amplification interface.
	--	Click it to go to image adjustment interface. Refer to 5.4.5 Image Adjustment for details.
	Start/Close Talk	Click it to start talk.
	Target detection	Click it to go to single channel target detection interface; the target includes faces, human bodies and vehicles. (only applicable to some models)
--	Camera Info	Click it to view the camera information.

The single channel amplification interface is as shown below. Press and drag the blue box to select the zoom in area. Click  /  to zoom the image. Click the camera selection box to select other cameras for amplification. Click “Back” to return to the live preview interface.



5.2 View Mode

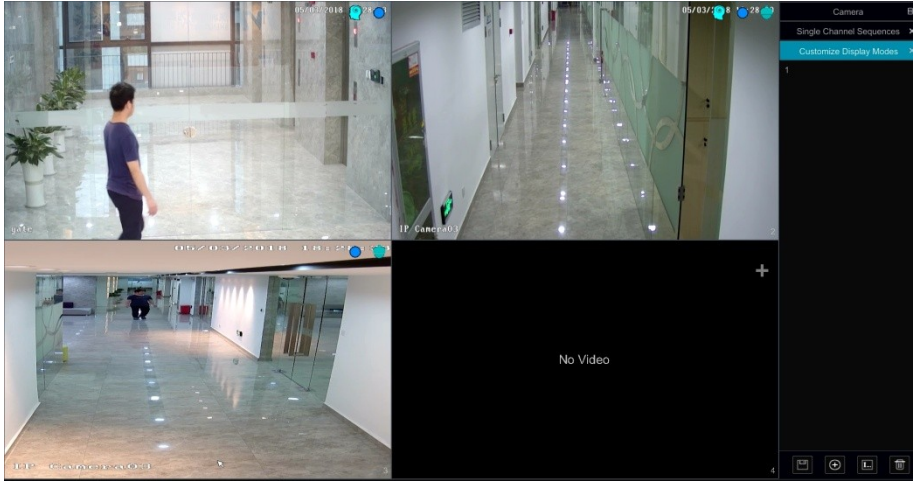

5.2.1 Preview by Display Mode

Set different screen modes and cameras’ display sequences as required and then save the display modes classified by surveillance areas, priorities and so on. Refer to the picture below. Double click one display mode in the display mode list to view the live images in this mode.



➤ Add Display Mode



Method One:

- ① Click “Customize Display Modes” in the above interface
- ② Click  to add a display mode name and then set the screen mode.
- ③ Add the cameras and adjust the cameras’ display sequence as required.
- ④ Click  under the display mode list.

Method Two:

- ① Click Start→Settings→System→Basic→Output Settings to go to the interface and then set the screen mode.
- ② Double click the camera or camera group in the list to add them to the selected window.
- ③ Click  to save the current display mode (refer to [5.2.4 Scheme View In Sequence](#) for detail configurations). The display mode will be saved and displayed in the display mode list in the live preview interface.

➤ Edit Display Mode

Click “Customize Display Modes” tab in the live preview interface and then select one display mode in the list. Click  to edit the display mode name; click  to delete the display mode.

➤ Corridor Pattern

Some models may not support this function.

Select corridor pattern in display mode. You can change the direction of the video image by using this function. Please refer to User Manual of relevant camera.

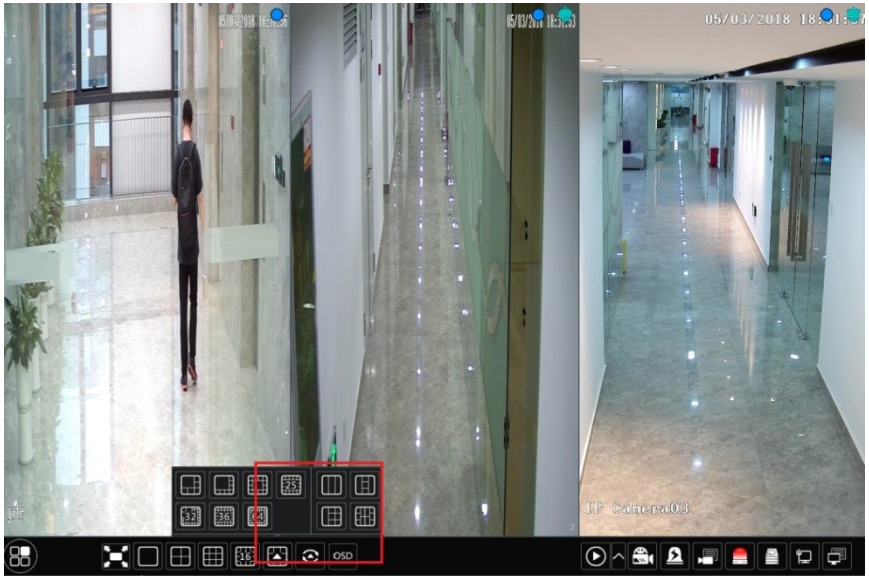

Change to corridor pattern

➤ Fisheye Mode

Some models may not support this function.

In the live view interface, select the view mode according to the installation mode and display mode of the fisheye camera. Please refer to User Manual of the relevant fisheye camera.

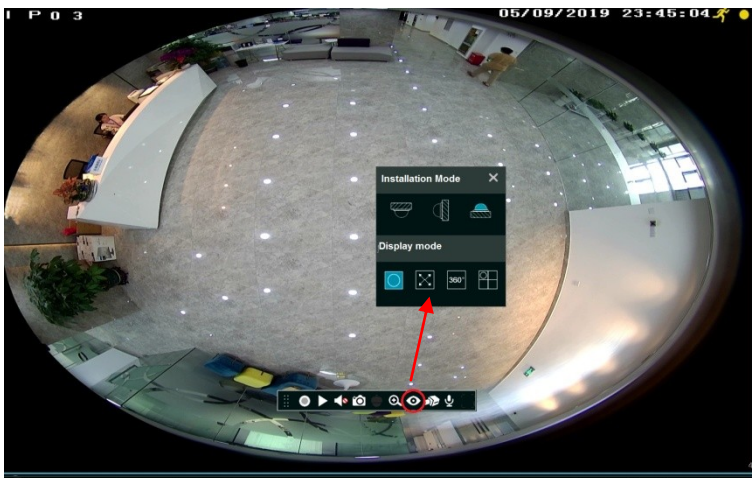



In addition, if this function is unavailable in the device, you can set the display mode and the installation mode via Web Client. To log in the web client, please refer to Chapter 14 for details.

5.2.2 Quick Sequence View

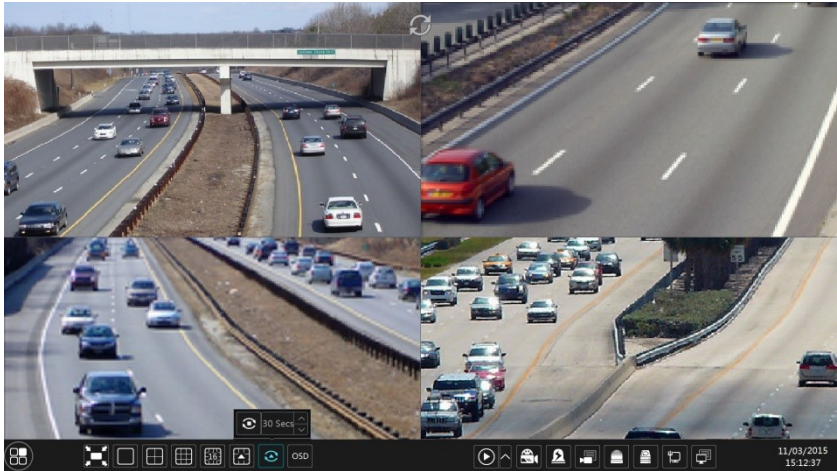
You can start quick sequence view if the scheme has not been created. If the scheme has been created, please refer to [5.2.4 Scheme View in Sequence](#) for details.



Go to the live preview interface and then click  to pop up a little window. Set the dwell time in the window and then click  to view the live group by group according to the camera number of the current screen mode. Double click the sequence view interface to pause the view; double click again to restore the view. Click  to stop the view.

5.2.3 Camera Group View in Sequence

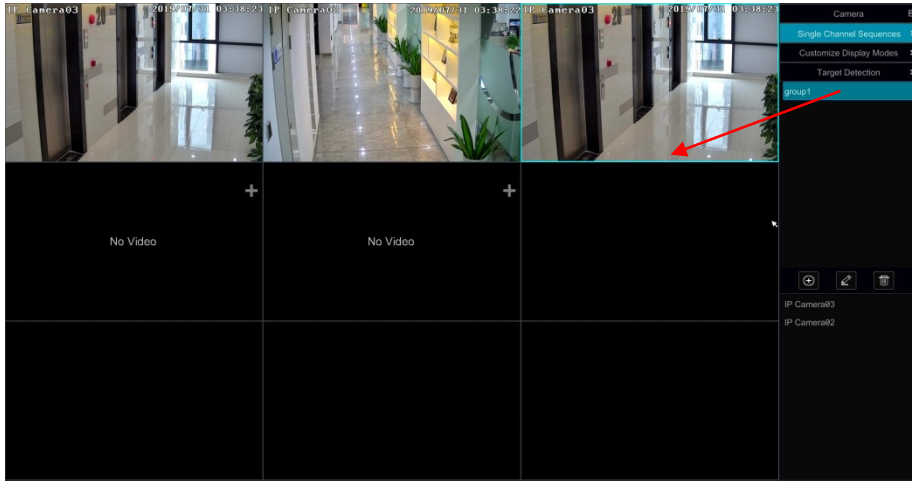

You can start camera group view in sequence if camera group has been created (see [4.2.1 Add Camera Group](#) for details).

- ① Go to the live preview interface and then select a camera window.





② Double click one camera group on the right side of the interface. The cameras in the group will start camera group view one by one in the selected camera window.

You can also drag the group directly to any preview window. Right click on the group view window and then click “Close Dwell” to stop the view.

Click  to add camera group. Select a group and click  to modify the group name and dwell time; Select a group and click  to delete the group.

5.2.4 Scheme View in Sequence

Click Start→Settings→System→Basic→Output Settings to go to the interface as shown below. Area ① displays all the dwell schemes; area ② shows the detailed information of the scheme; area ③ displays all the cameras and groups; area ④ is the tool bar (: clear button; : favorite button, click it to pop up a window, enter the display mode name in the window and then click “OK” to save the current display mode; other buttons are screen mode buttons).

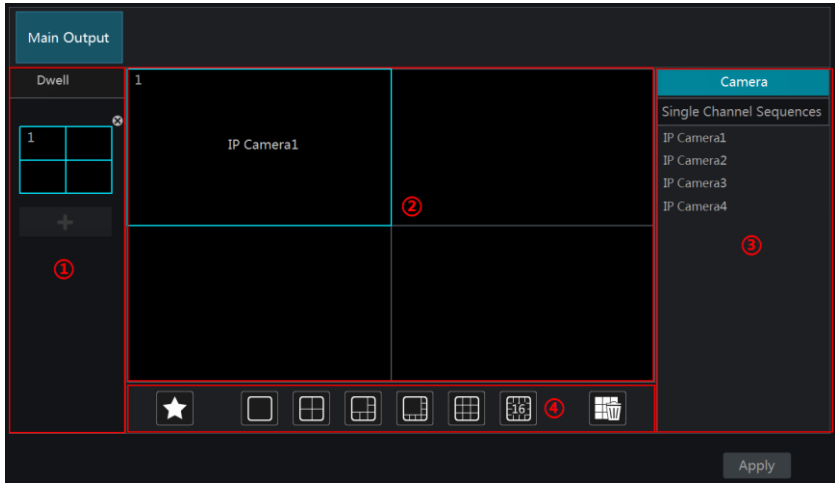



➤ Add Scheme

Click **+** in area ① to create a new scheme. Click **x** on the top right corner of the scheme to delete it.

➤ Configure Scheme

- Select a scheme in area ① and then click the screen mode button on the tool bar to set the screen mode of the scheme.
- Select a camera window in area ② and then double click the camera or group in area ③. The camera or group will be added into the selected window. One camera in the same scheme cannot repeat. You can click the right-click menu “Clear” in area ② to remove a single camera or click  to remove all the cameras.
- Click “Apply” to save the settings.

➤ Start Sequence View

Go to live preview interface and then click  to pop up a window. Set the dwell time in the window and then click  to start scheme view in sequence. Double click the sequence view interface to pause the view; double click again to restore the view. Click  to stop the view.

Note:

You can set the secondary output preview if the NVR has dual outputs. Refer to the interface as shown below.

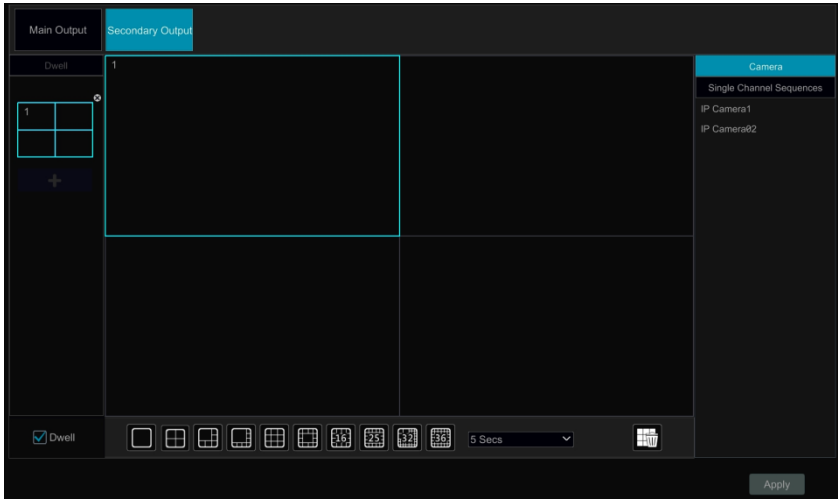

Check “Dwell” and then set scheme view in sequence of the adjutant output. The setting steps are similar to that of the main output.

Set quick sequence view if “Dwell” is not checked. The setting steps are as follows:

- ① Set screen mode by clicking the relevant buttons on the tool bar.
- ② Select one window and then double click one camera or group in the list.
- ③ Click “Apply” to save the settings after adding cameras or groups to the windows.

For the device with multi-output mode and AI mode, the secondary output will be unavailable after AI mode is enabled. If you want to enable secondary output, please click Start→System→Output Settings.

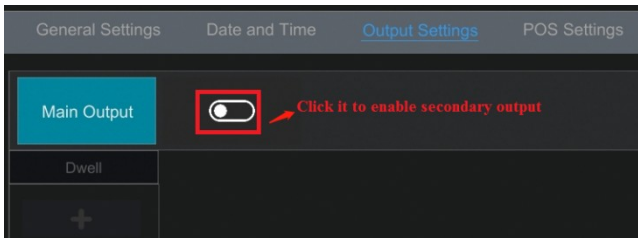

5.3 POS Settings

- ① Click Start→Settings→Basic→POS Settings to go to the interface.
- ② Enable POS and click “Configure” under “Connection Settings” to go to the following interface. The connection way includes TCP Listen, TCP Client, UDP and Multicast.
- ③ Enter IP address of the POS you want to add.
- ④ Check “POS port” and then enter POS port.

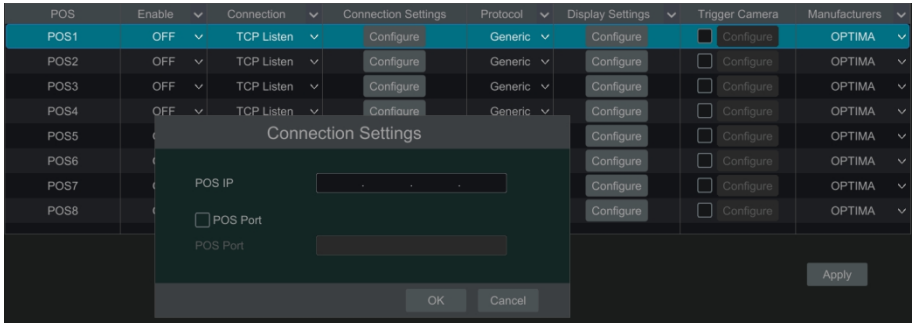

⑤ Click “Configure” under “Display Settings” to set the general settings, the position and display color of the POS information. Set the start character and the end character and display time-out period in the general settings interface. Drag your mouse to set the position of the POS information in the display position interface. Then click “OK” to confirm your settings.

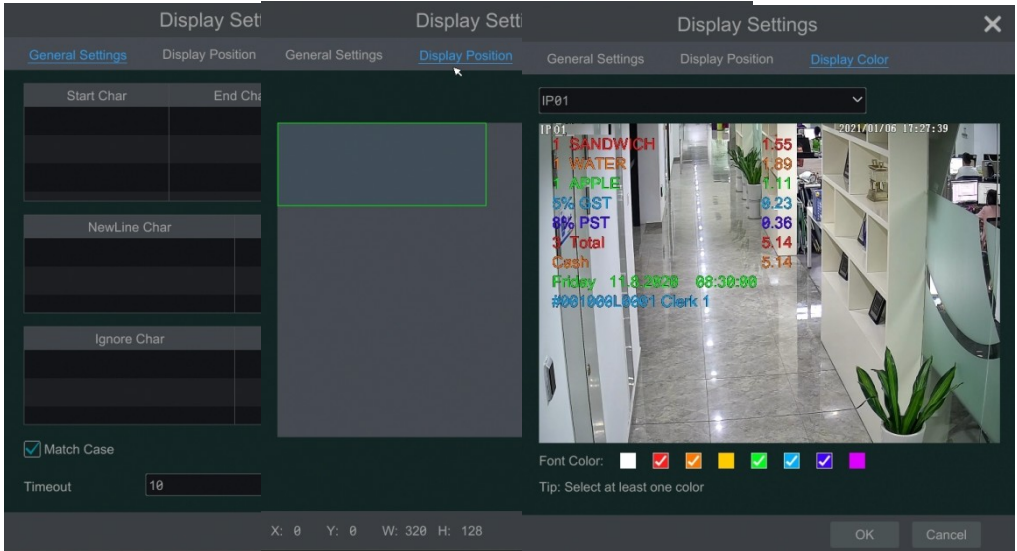

Click the “Display Color” tag and then choose the color you want to display on the screen. Multi-color can be selected at the same time.

⑥ Check “Trigger Camera” and click “Configure” under it to bind POS to the camera. One POS can be bound to multiple channels, but one channel can only be bound to one POS.

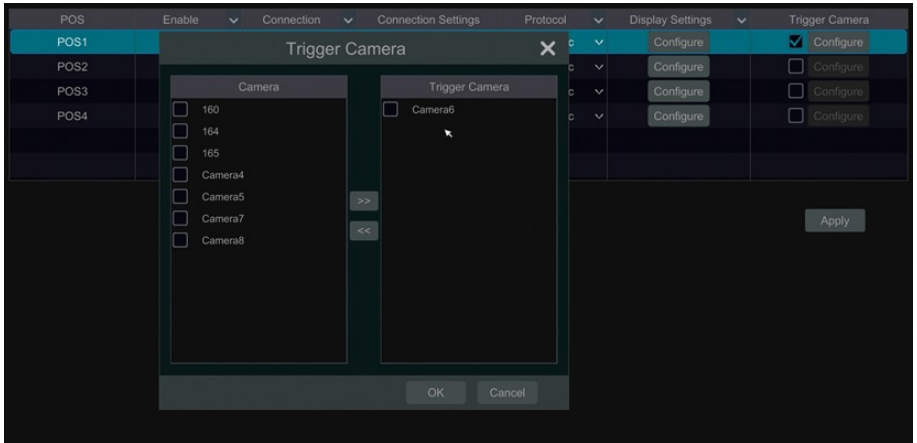

- ⑦ Choose the manufacturer of the POS device.
 - ⑧ Click “Apply” to save the settings and then the transaction information will be displayed on the preview image in real-time.
- One POS is bound to one camera:

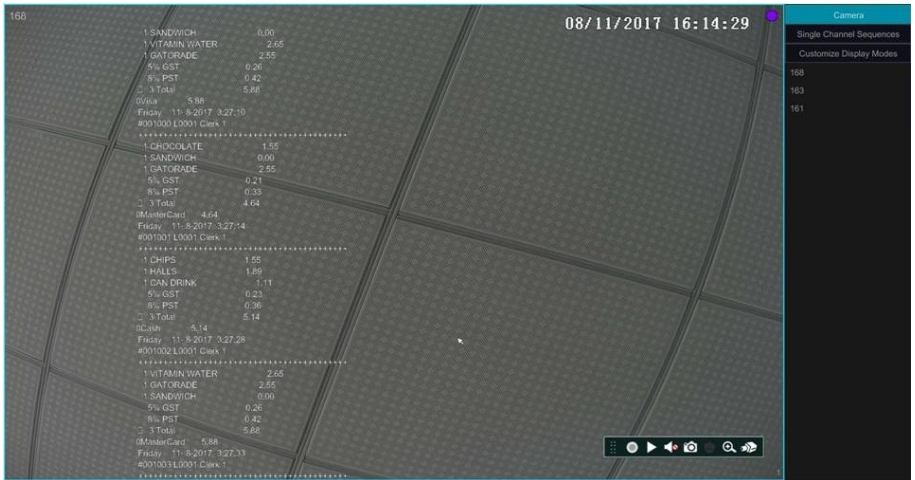

One POS is bound to multiple cameras:

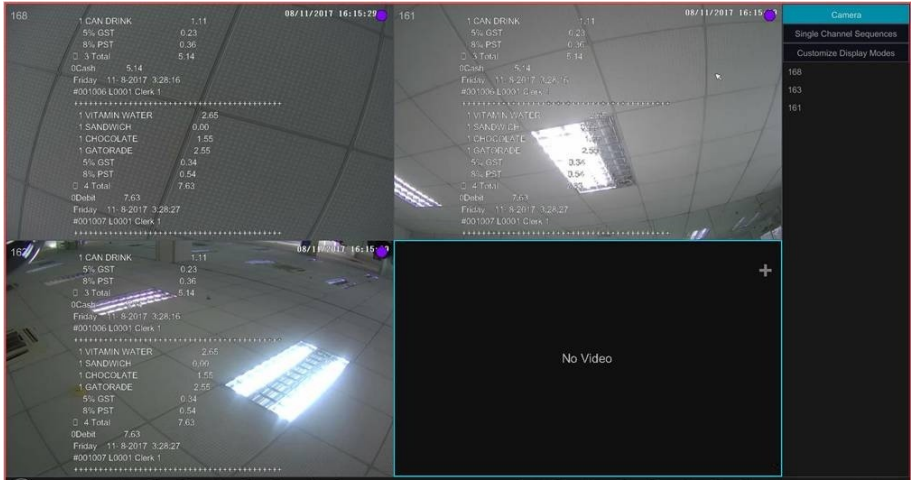

5.4 Preview Image Configuration

5.4.1 OSD Settings

Click Start→Settings→Camera→Image→OSD Settings to go to the interface as shown below. Select the camera, enter the camera name (or double click the camera name in the camera list to change the camera name), enable or disable the name and time OSDs (if enabled, drag the red name and time OSDs directly in the image view area to change the OSDs' display position) and select the date and time formats. Additionally, water mark can be enabled or disabled here. Having enabled the water mark function, you can enter the information of the water mark as needed. Finally, click “Apply” to save the settings.

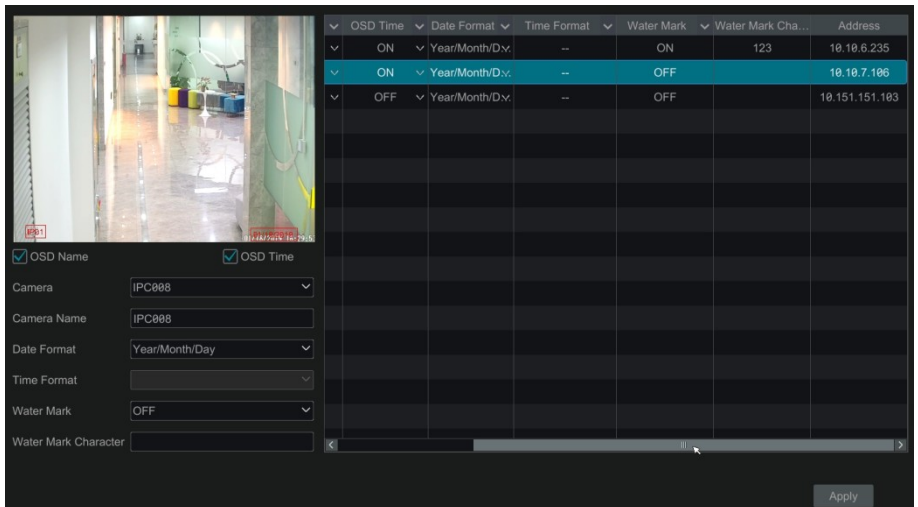

5.4.2 Image Settings

Click Start→Settings→Camera→Image→Image Settings to go to the following interface. Select the camera and then set the brightness, contrast, saturation and hue of the camera. Click the “Advanced” button or  in the camera list on the right side of the interface to pop up the “Image Adjust” interface and then set the relevant setting items. Please refer to [5.4.5 Image Adjustment](#) for detailed introductions of these items.

You can click “Default” to restore the image settings to the default factory settings.

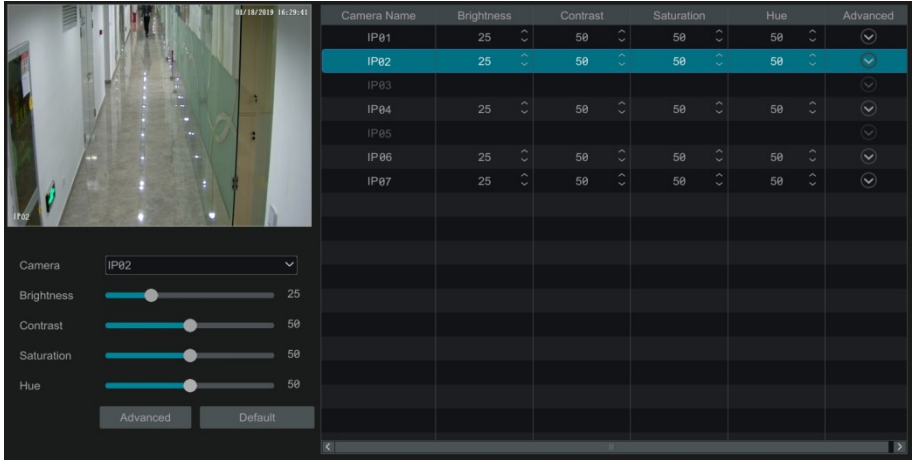

5.4.3 Mask Settings

Some areas of the image can be masked for privacy. Up to four mask areas can be set for each camera. Click Start→Settings→Camera→Image→Mask Settings to go to the interface as shown below.

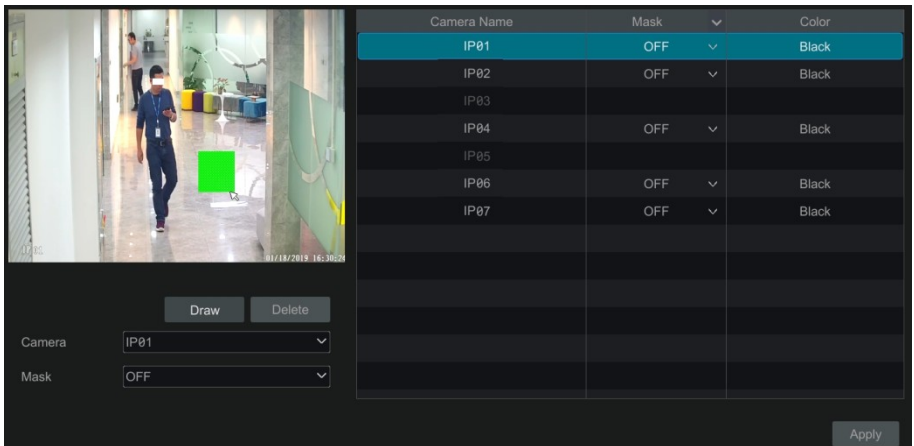

Select the camera and enable the mask. Click the “Draw” button and then drag the mouse on the image area to set the mask area; click the “Delete” button to delete the mask areas; click “Apply” to save the settings.

5.4.4 Fisheye Settings

Some models may not support this function.

Click Start→Settings→Camera→Image→Fisheye Settings to go to the interface as shown below. Select the camera and the mode of fisheye and installation.



5.4.5 Image Adjustment

Go to live preview interface and then click  button on the tool bar under the camera window to go to the image adjustment interface.

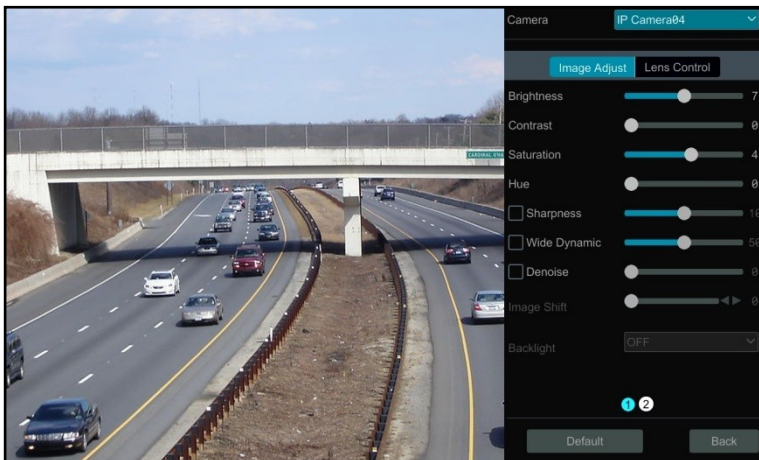



➤ Image Adjustment

Select the camera and then click “Image Adjustment” to go to image adjustment tab. Refer to the above picture. Drag the slider to set the camera’s brightness, contrast, saturation and hue value. Check sharpen, wide dynamic and denoise and then drag the slider to set the value. Click “Default” to set these parameters to default values. The introductions of these parameters are as follows:

Parameter	Meaning
Brightness	It is the brightness level of the camera’s image.
Contrast	It is the color difference between the brightest and darkest parts.
Saturation	It is the degree of color purity. The color is purer, the image is brighter.
Hue	It relates to the total color degree of the image.
Sharpen	It relates to the resolution level of the image plane and the sharpness level of the image edge.
Wide Dynamic	The wide dynamic range (WDR) function helps the camera provide clear images even under back light circumstances. When there are both very bright and very dark areas simultaneously in the field of view, WDR balances the brightness level of the whole image and provide clear images with details.
Denoise	Decrease the noise and make the image more thorough. Increasing the value will make the noise reduction effect better but it will reduce the image resolution.
White Balance	Adjust the color temperature according to the environment automatically.
BLC	HLC: lowers the brightness of the entire image by suppressing the brightness of the image’s bright area and reducing the size of the halo area. BLC: If enabled, the auto exposure will activate according to the scene so that the object of the image in the darkest area will be seen clearly.
Corridor Pattern	0°, 90°, 180° or 270° can be selected. (Only some cameras support this pattern)
Image Mirror	Turn the current video image horizontally.
Image Flip	Turn the current video image vertically.
High FPS Mode	High frame rate mode, if is it enabled, the frame rate of the camera’s main stream can be set to 1080P/720P @60fps/50fps. (Only some cameras support this mode)

Note: The above-mentioned descriptions of the image parameters are for reference only. The cameras made by different manufacturers may have different parameter settings.

➤ Lens Control

Select the camera and then click “Lens Control” to go to lens control tab. Click  or  to adjust the zoom and focus parameters of the camera’s lens. Click “Save” to save the settings.



The introductions of these parameters and buttons are as follows.

Button/Parameter	Meaning
	Click / to zoom in/out the image.
Focus Mode	If manual mode is selected, focus button & “One Key Focus” & “Day/night mode switch autofocus” will be available; if auto mode is selected, the time interval setup will be available.
	Click / to increase/decrease the focal length.
	Click it to focus instantly.
Day/night mode switch autofocus	If checked, the lens will focus automatically when the camera is switching day/night mode.
Time Interval	It is the time interval when camera lens is auto-focusing. The interval can be set in the drop-down list.

Note: if the lens of the camera connected to the NVR is fixed, the lens control function is unavailable.

6 PTZ

6.1 PTZ Control Interface Introduction

You can control the IP dome or PTZ which connects to the IP camera for PTZ control.



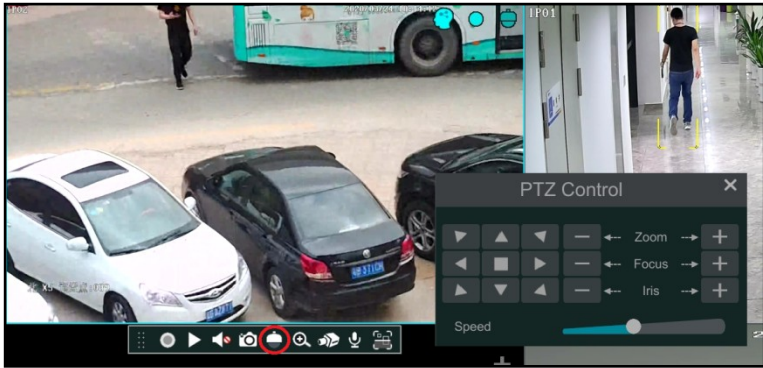



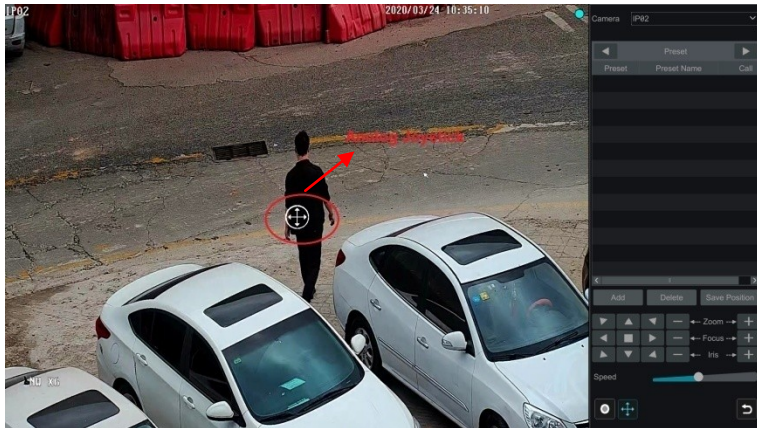













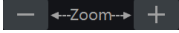

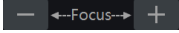

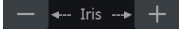
Click  on the tool bar at the bottom of the live preview window to go to the PTZ control interface as shown below.



The direction, zoom, focus, iris and speed can be controlled in the small PTZ control window. Right click the PTZ/speed dome camera window and select “PTZ Control” to go to the PTZ control panel as shown below.



Introductions of the buttons on the bottom right of the interface:

Button	Meaning
	Click  /  /  /  /  /  /  /  /  to rotate the dome. Click  to stop rotating the dome.
	Click  /  to zoom in / out the camera image.
	Click  /  to increase / decrease the focal length.
	Click  /  to increase / decrease the iris of the dome.
	Drag the slider to adjust the rotating speed of the dome.
	Click  /  to start / stop recording.
	Click  /  to hide / show the analog joystick.
	Click it to return to the live preview interface.

➤ Analog Joystick Control

The analog joystick on the left side of the interface provides quick PTZ control. The dome or PTZ will rotate when you drag the analog joystick. The farther you drag the analog joystick from the middle of the image, the faster the dome or PTZ rotates. The dome or PTZ will stop rotating when you stop dragging the analog joystick.

➤ 3D Control

Click the camera image on any area and then the image will be centered on the clicked point. Refer to the picture as shown below. Drag the mouse from A to B to get a green rectangle and the rectangle area will be zoomed in.



Refer to the picture as shown below. Drag the mouse from C to D to get a green rectangle and the rectangle area will be zoomed out.

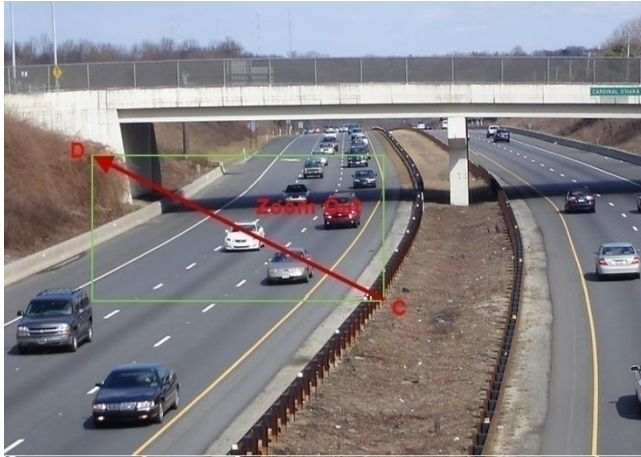

➤ Advanced 3D Control

Double click the left button of the mouse on any area of the camera image and then the image size will be doubled and centered on the clicked point.

Press and hold the left button of the mouse on any area of the camera image to zoom in the image; press and hold the right button to zoom out the image.

Move the cursor of the mouse to the camera image and then slide the scroll wheel of the mouse forward to zoom in the image, slide the scroll wheel of the mouse backward to zoom out the image.

➤ Preset Settings

Click “Preset” to go to preset operation tab and then click “Add” to pop up a window as shown below. Select the preset and then enter the preset name in the window; finally click “OK” to save the settings. You can add 255 presets for each dome at most.

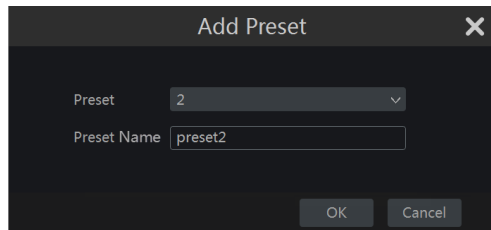

Adjust the dome’s direction and then click “Save Position” to save the current preset position (you can also click another preset in the preset list and then save the preset position after adjusting the dome’s direction); click  in the preset list to call the preset; click “Delete” to

delete the selected preset.

You can also go to preset setting interface for preset setting, see [6.2 Preset Setting](#) for details.



➤ Cruise Settings

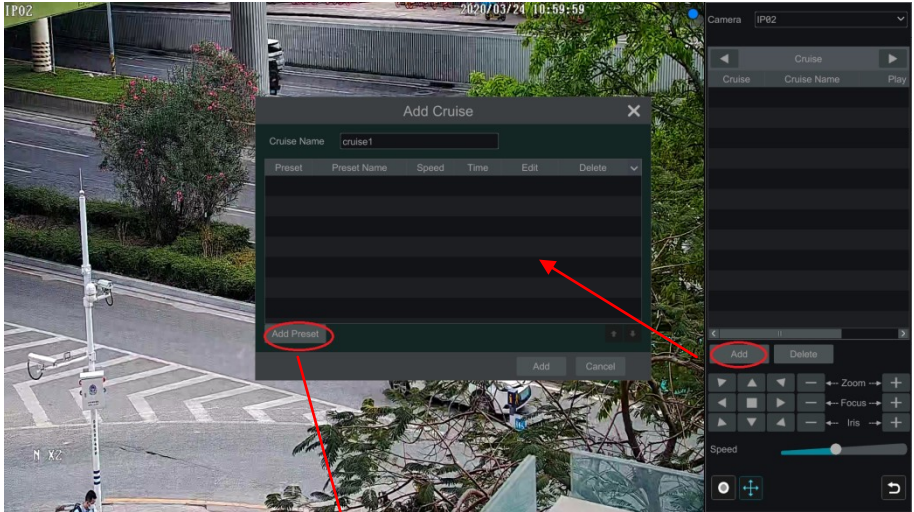

On the right panel, click  to go to cruise operation tab and then click “Add” to pop up a window as shown below left. You can add 8 cruises for each dome at most.



① Enter the cruise name in the “Add Cruise” window and then click “Add preset” to pop up the “Add Preset” window (Before adding preset to the cruise, please add preset of the dome first).

② In the “Add Preset” window, select the preset name, preset time and preset speed and then click “OK”.

③ In the “Add Cruise” window, you can click  to reselect the preset, then change the preset time and speed. Click  to delete the preset. Click “Add” to save the cruise.

Click  to start the cruise and click  to stop the cruise in the cruise list of the cruise

operation tab; click “Delete” to delete the selected cruise.

You can also go to cruise setting interface for cruise setting, see [6.3 Cruise Setting](#) for details.

➤ Cruise Group Settings

On the right panel, click  to go to the cruise group setting tab. Click “Add” to add a cruise group as shown below.

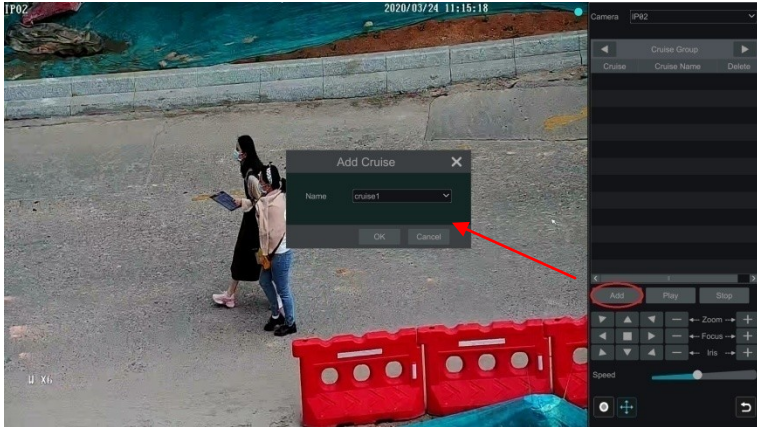



In the “Add Cruise” window, select the cruise line name. After that, click “Play” to play the cruise lines in sequence.

➤ Trace Settings

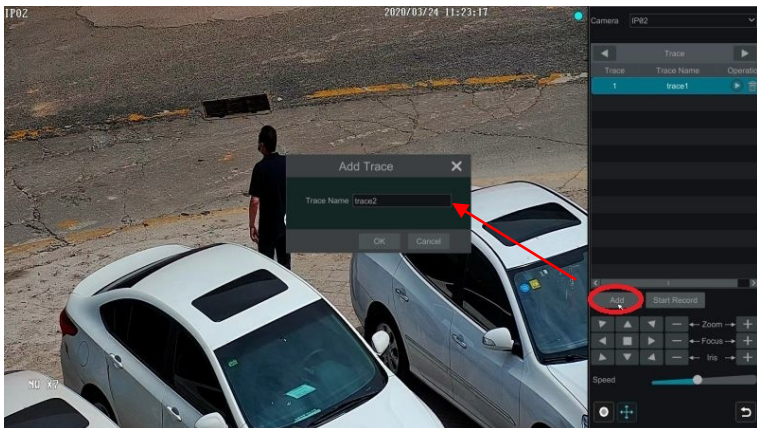
On the right panel, click  to go to the trace setting tab. Click “Add” to add the trace name. Then click “OK” to save this name. Please refer to the following picture.





After that, click “Start Record” to record the trace. Then click “Stop Record” to finish recording. Click  to play the recorded trace. Click  to delete the trace.

6.2 Preset Settings

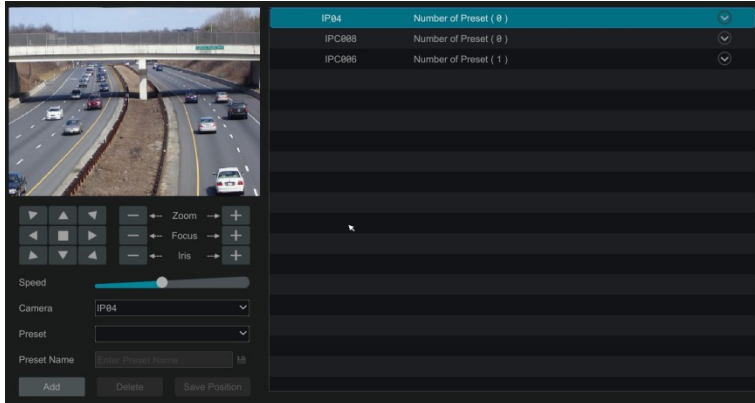
Click Start→Settings→Camera→PTZ→Preset to go to the interface as shown below.



➤ Add preset

Select camera and then click “Add” to add preset; or click  in the camera list on the right side of the interface to display the preset information of the dome and then click  to add preset. The operations of the “Add Preset” window are similar to that of the PTZ control interface; please see [6.1 PTZ Control Interface Introduction](#) for details.

➤ Edit preset

Select camera and preset. You can enter the new name of the preset and then click  to save the new preset name. Adjust the rotating speed, position, zoom, focus and iris of the preset and then click “Save Position” to save the preset.

➤ Delete Preset



Select camera and preset and then click “Delete” to delete the preset.

6.3 Cruise Settings

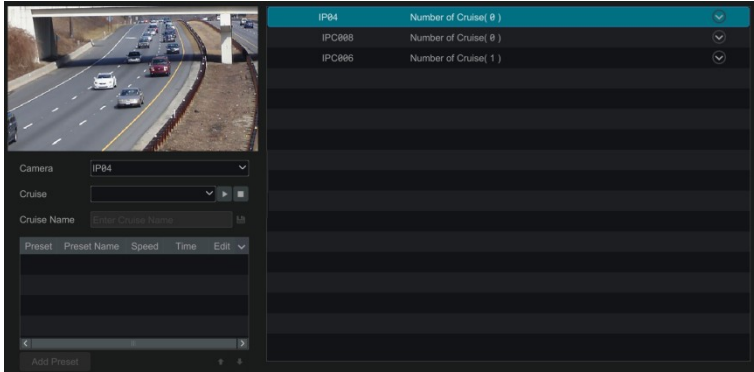





Click Start→Settings→Camera→PTZ→Cruise to go to the interface as shown below.





➤ Add Cruise

Click  in the camera list on the right side of the interface to display the cruise information of the dome and then click  to add cruise. The operations of the “Add Cruise” window are similar to that of the PTZ control interface; please see [6.1 PTZ Control Interface Introduction](#) for details.

➤ Edit Cruise

Select the camera and cruise in the “Cruise” interface. Enter the new cruise name and then click  to save the cruise name. Click “Add Preset” to add preset to the cruise. Click  to edit the preset. Click  to delete the preset from the cruise. Click one preset in the preset list and then click  to move down the preset and click  to move up the preset. Click  to start the cruise and click  to stop it.

➤ Delete Cruise

Click  in the camera list on the right side of the interface to display the cruise information of the dome and then click  on the top right corner of the cruise to delete the cruise.

6.4 Cruise Group Settings

Click Start→Settings→Camera→PTZ→Cruise Group to go to the interface as shown below.

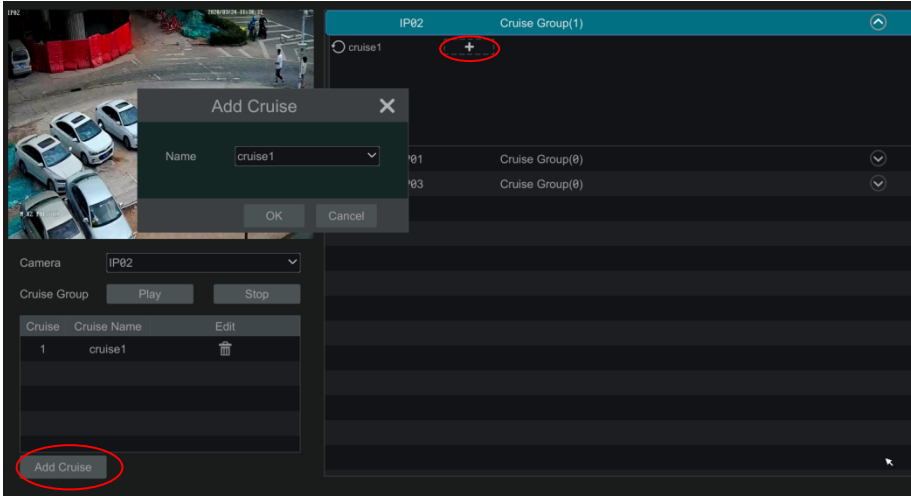

➤ Add Cruise Group

Click “Add Cruise” to add the cruise, or click  to extend the cruise list and then click  to add the cruise. After that, click “Play” on the left panel as shown below to play the cruise lines in sequence.



➤ Delete Cruise

In the cruise list, click  to delete the cruise.

6.5 Trace Settings



Click Start→Settings→Camera→PTZ→Trace to go to the interface as shown below.

➤ Trace Record

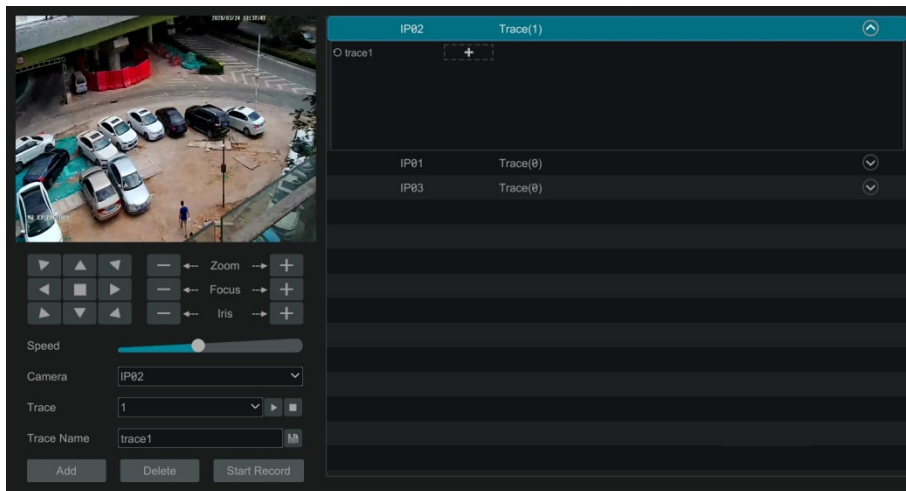
Select the PTZ camera and then click “Add” or extend the IPC information by clicking  and then click  to add a trace name. After that, click “Start Record” and move the speed dome to change its position and set its trace. Then click “Stop Record” to complete the trace record.





➤ Play or Stop Trace

Select the trace and click  to play the trace; click  to stop the trace.

➤ Modify the Trace Name

On the left panel, enter new trace name and click  to modify and save the trace name.

➤ Delete the Trace

Click  to delete the trace. Or put the cursor on the trace name (right panel) and then  will appear on the right corner of the trace name; click it to delete this trace.

6.6 Task Settings

Click Start→Settings→Camera→PTZ→Task to go to the interface as shown below.

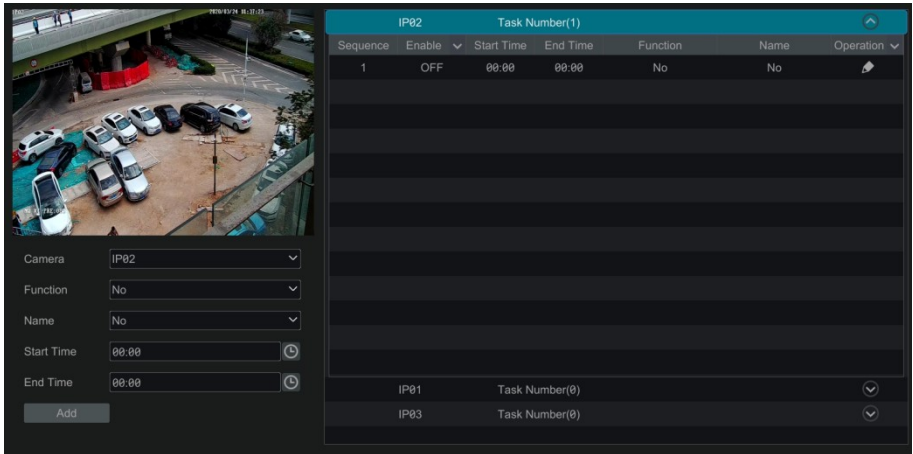

- ① Select a PTZ camera.
- ② Select function, such as preset, cruise, trace, random scanning, etc.
- ③ Select a name, such as preset name, cruise name, etc.
- ④ Select the start and end time.
- ⑤ Click “Add” to add the task.
- ⑥ Click to extend the tasks of the PTZ camera. Click beside “Enable” to enable the task. After the task is enabled, the PTZ camera will start the specific task at the specified time.

6.7 Smart Tracking

This function is only available for AI PTZ camera. Please add the AI PTZ camera to the NVR first. Then this function will take effect.

Smart Tracking: When people or vehicle cross the alarm line or intrude the predefined area, the PTZ camera can automatically track them and the target image will be automatically zoomed in and centered on the screen until the target disappears on the screen. After that, the PTZ camera will return to the tracking start position.

To set smart tracking:

1. Click Settings→Camera→Smart Tracking to go to the smart tracking interface.

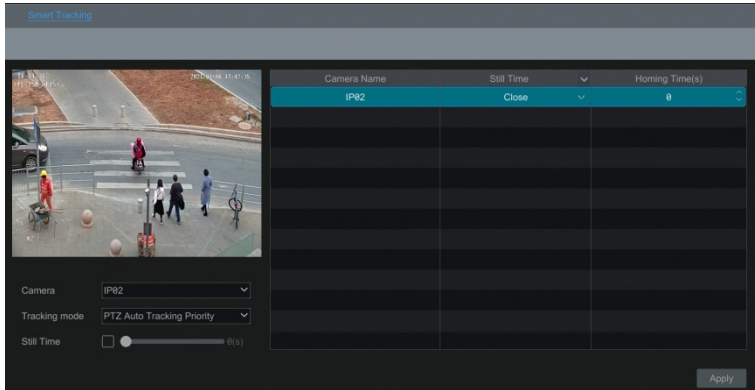

2. Select the tracking mode and set the still time as needed.

Tracking Mode: PTZ Auto Tracking Priority or Manual PTZ Control Priority can be optional.

PTZ Tracking Priority: if this mode is selected, after enabling “Trigger track” in one of the following events, you cannot control PTZ by clicking the buttons on the PTZ control panel in the live view interface.

Manual PTZ Control Priority: if this mode is selected, after enabling “Trigger track” in one of the following events, you can control PTZ by clicking the buttons on the PTZ control panel in the live view interface during the process of smart tracking. After you stop controlling for 5 seconds, the PTZ camera will return to the pre-defined detection area and start tracking again when detecting a target.

Still time: If it is enabled and the time is set, when the target stops or hides behind an obstacle, or the target tracking is complete and there is no target appearing in the detection area during the set time, the PTZ camera will return to the tracking start position. Of course, during this time, if there are targets moving, the PTZ will continue tracking. If it is not enabled, when the target stops or there is no target appearing in the detection area for 5 seconds, the PTZ camera will return to the start tracking position.

For example: in the crossroad, if a car is waiting for the red light for 30 seconds, and the still time is set as 20 seconds, then the tracking will stop following; but if the still time is set as 40 seconds, after the red light start to change into green light, then the car re-start to move, and the PTZ will keep on tracking this car.

3. Click Settings→AI/Event→AI Event. Select the AI PTZ camera and the event as needed (Line Crossing/Intrusion). For example: intrusion.

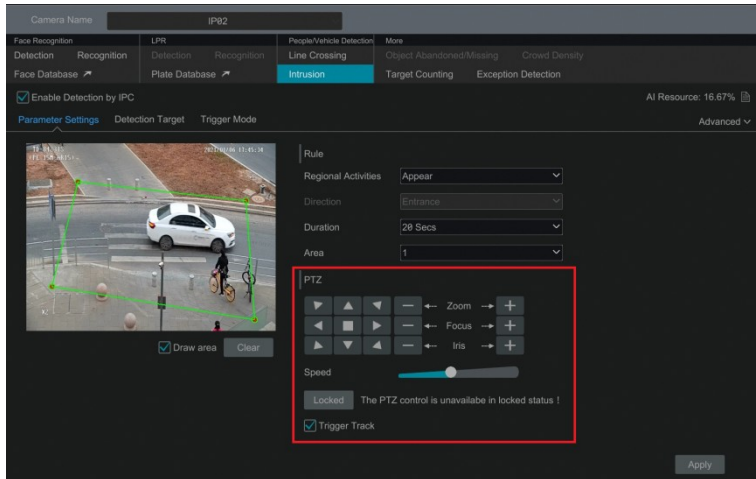

4. Enable the event, set the rule and then click “Locked”. This button will be changed to “Unlock”. Now the PTZ control panel in the above interface will be activated. Set the detection area by clicking the directional buttons in the above interface. After that, click “Unlock” to lock the detection area.
5. Click “Draw area” and then draw the intrusion region on the screen. After that, check “Trigger Track” and click “Apply” to save the settings.
6. Set the detection target.

7 Record & Disk Management

7.1 Record Configuration

7.1.1 Mode Configuration

Please format the HDDs before recording (refer to [7.4.1 Disk Management](#) for details). Click Start→Settings→Record→Mode Settings to go to the mode settings interface. You can set the record time under the “Manual Record Settings” and then click “Apply” to save the settings. There are two record modes: auto mode and manual mode.

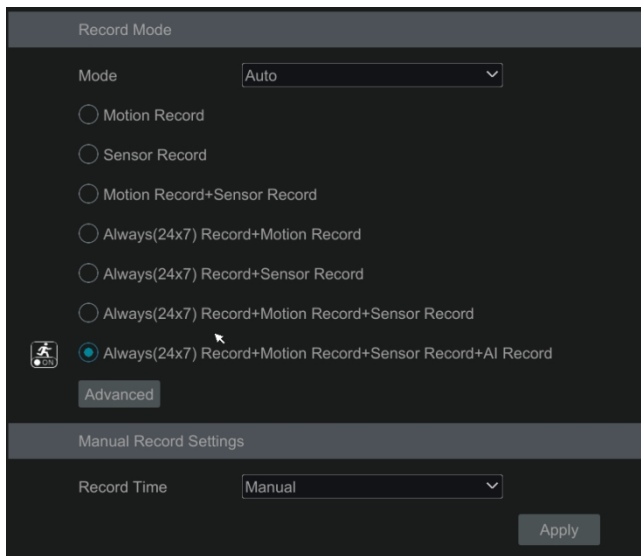

➤ Auto Mode

Motion Record: Motion alarm record will be enabled when motion alarm happens.

Sensor Record: Sensor alarm record will be enabled when sensor alarm happens.

Motion Record+Sensor Record: Motion/sensor alarm record will be enabled when motion/sensor alarm happens.

Always(24 x 7) Record+Motion Record: Normal record is enabled all the time; motion alarm record will be started when motion alarm happens.

Always(24 x 7) Record+Sensor Record: Normal record is enabled all the time; sensor alarm record will be started when sensor alarm happens.

Always(24 x 7) Record+Motion Record+Sensor Record: Normal record is enabled all the time; motion/sensor alarm record will be enabled when motion/sensor alarm happens.

Always(24 x 7) Record+ Motion Record + Sensor Record + AI Record: Normal record is enabled all the time; AI record will be enabled when AI event happens.

You can add more auto modes on analytics record. Click “Advanced” to pop up a window as

shown below. Check the modes in the window and then click “Add” to show the modes in the record mode list (in the window, the checked modes can be shown in the record mode list while the unchecked modes cannot; you shall check “*AI Record*”).

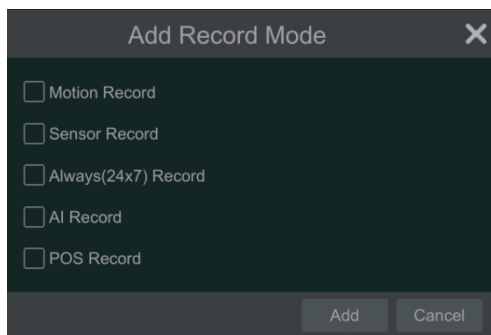

Select one auto mode to pop up the corresponding window. Set the encode, GOP, resolution, FPS, bitrate type, quality, max bitrate and audio of each camera and then click “OK” to save the settings. Please adjust the parameters according to the actual condition.

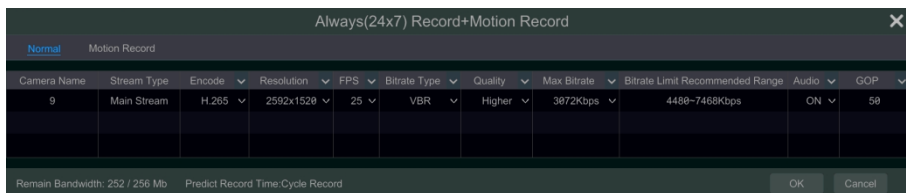

Video Encode: the available options will be H.265S, H.265+, H.265, H.264S, H.264+ and H.264. If the connected IP camera doesn’t support H.265s, H.265+, H.264S, H.264+, the corresponding options will not be shown.

Resolution: the higher the resolution is, the clearer the image is.

FPS: the higher the frame rate is, the more fluency the video is. However, more storage room will be taken up.

Bitrate Type: CBR and VBR are optional. CBR means that no matter how much change is seen in the video scene, the compression bitrate will be kept constant. VBR means that the compression bitrate will be adjusted according scene changes. For example, for scenes that do not have much movement, the bitrate will be kept at a lower value. This will help to optimize the network bandwidth.

Quality: When VBR is selected, you need to choose image quality. The higher the image quality you choose, the more bitrate will be required.

Max Bitrate: 32Kbps ~10240Kbps are optional.

GOP: group of pictures.

➤ Customization Mode

If the customization mode is selected, you need to set the record schedules of each camera. See [7.1.2 Schedule Settings](#) for details.

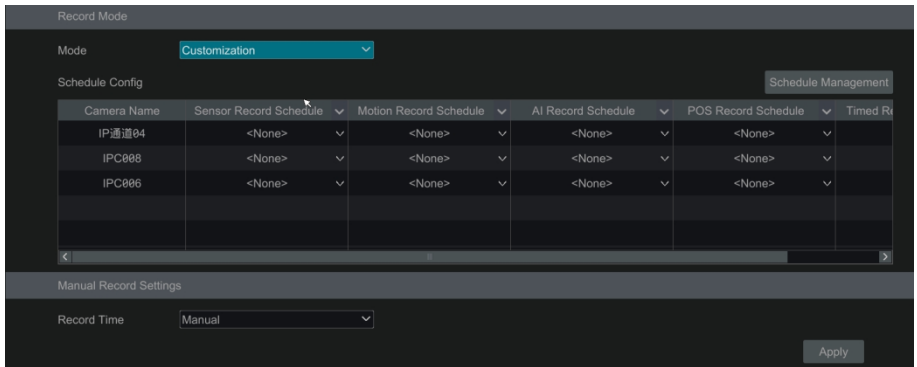

In this interface, you can also set the record period of the manual record in the live view interface.

7.1.2 Schedule Settings

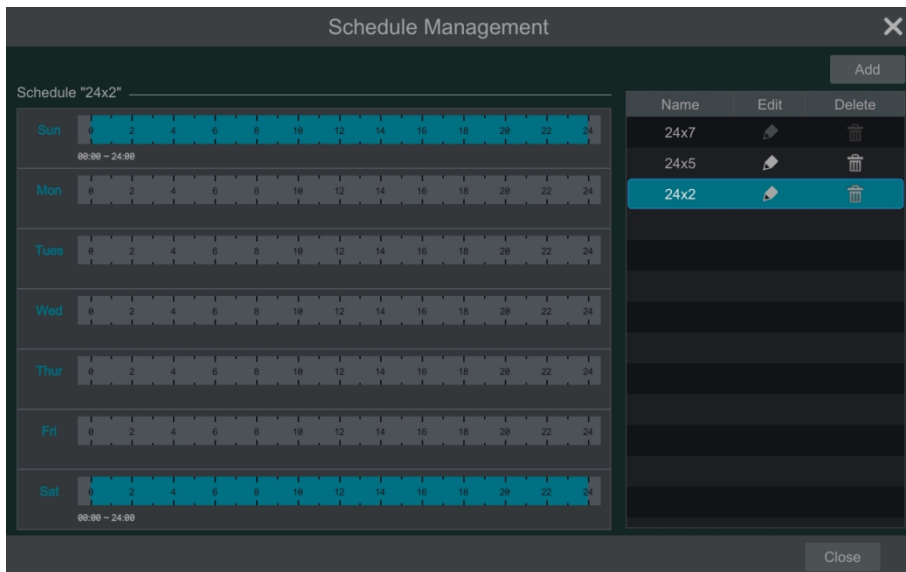

➤ Add Schedule

Click Start→Settings→Record→Mode Setting to go to the mode setting interface. Then select “Customization” mode and click “Schedule Management” to set the schedule as shown below. “24 x 7”, “24 x 5” and “24 x 2” are the default schedules; you cannot edit or delete “24 x 7” while “24 x 5” and “24 x 2” can be edited and deleted. Click the schedule name to display the detailed schedule information on the left side of the interface. The seven rows stand for the seven days in a week and each row stands for 24 hours in a day. Blue stands for the selected time and gray stands for unselected time.



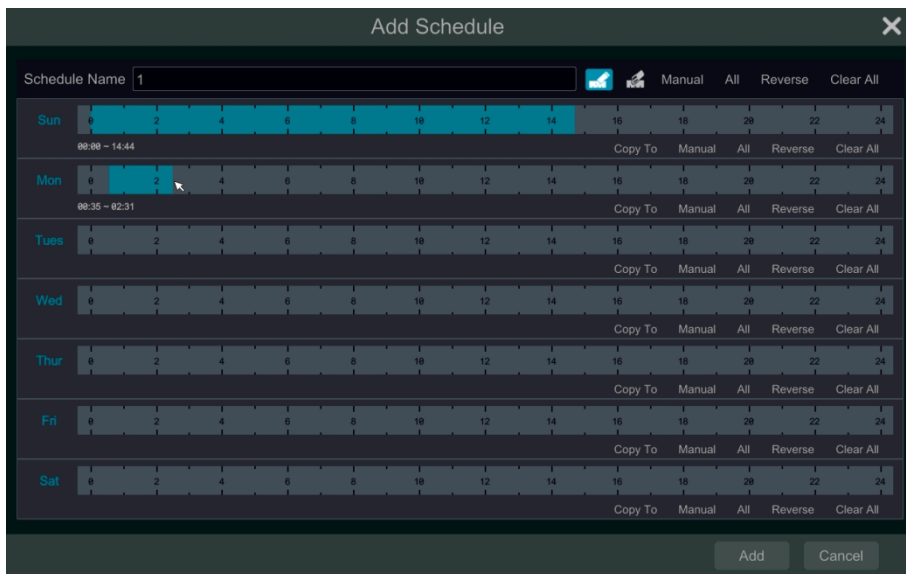



Click “Add” to add a new schedule. Refer to the picture below.



Set the schedule name and schedule time and then click “Add” to save the schedule. You can set day schedule or week schedule. : add button; : delete button.

➤ Set Day Schedule

Click  and then drag the cursor on the time scale to set record time; click  and then drag the cursor on the time scale to delete the selected area.

You can manually set the record start time and end time. Click  or  and then click “Manual” on each day to pop up a window as shown below. Set the start and end time in the window and then click “OK” to save the settings.

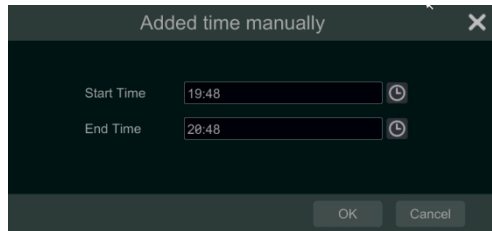

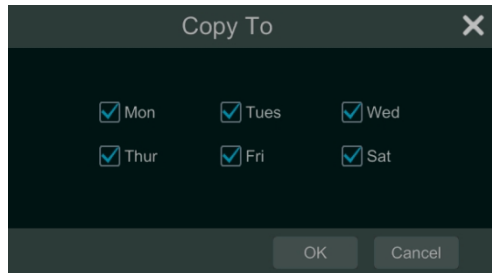

Click “All” to set all day recording; click “Reverse” to swap the selected and unselected time in a day; click “Clear All” to clear all the selected area in a day.

Click “Copy To” to copy the schedule of the day to other days. Refer to the picture below. Check the days in the window and then click “OK” to save the settings.



➤ Set Week Schedule

Click  or  and then click “Manual” beside  to set the week schedule. Refer to the picture below. Set the start and end time, check the days in the window and then click “OK” to save the settings.

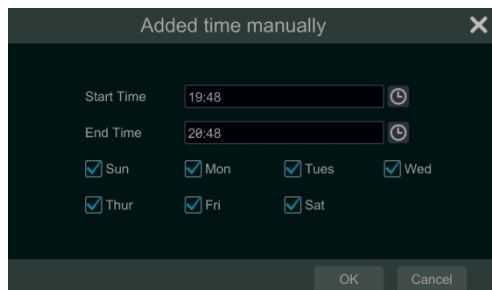

Click “All” to set all week recording; click “Reverse” to swap the selected and unselected time in a week; click “Clear All” to clear all the selected area in a week.

7.1.3 Advanced Configuration

Click Start→Settings→Record→Advanced to go to the following interface. Enable or disable cycle record (cycle record: the earliest record data will be replaced by the latest when the disks are full). Choose the record stream. Set the pre-alarm record time, post-alarm record time and expiration time of each camera and then click “Apply” to save the settings.

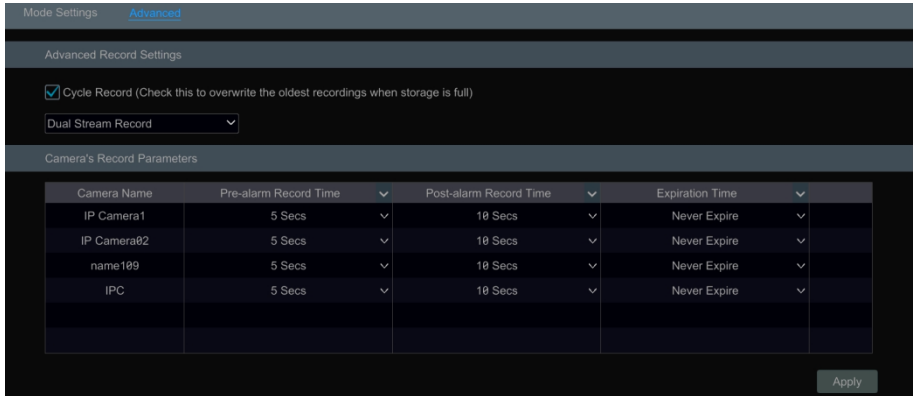

Pre-alarm Record Time: set the time to record before the actual recording begins.

Post-alarm Record Time: set the time to record after the actual recording is finished.

Expiration Time: set the expiration time for recorded video. If the set date is overdue, the recorded data will be deleted automatically.

7.2 Encode Parameters Settings

Click Start→Settings→Record→Encode Parameters to go to the interface as shown below. Set the encode, resolution, FPS, GOP, bitrate type, quality, max bitrate and audio of main stream for each camera in “Event Recording Settings” and “Schedule Recording Settings” interfaces. Click “Apply” to save the settings. You can set the record stream of each camera one by one or set them in bulk for all cameras.

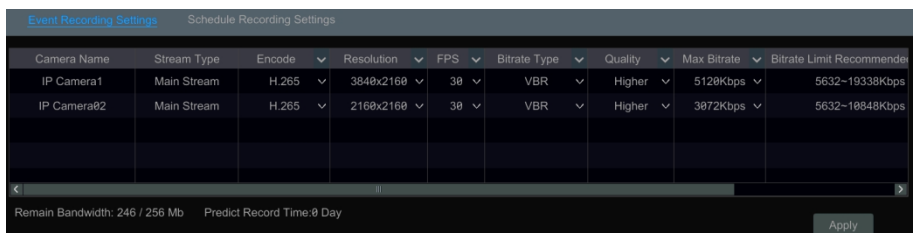

7.3 Record Mode

7.3.1 Manual Recording

Method One: Click  on the tool bar at the bottom of the live preview interface to enable recording of the camera.

Method Two: Go to live preview interface and then click the right-click menu “Manually Record On” in the camera window or click  on the tool bar under the camera window to start recording.

Note: Click Start→Settings→Record→Mode Settings and then set the manual record time in the interface. Click “Apply” to save the settings.

7.3.2 Timing Recording

Timing Recording: the system will record automatically according to the schedule. Set the timing record schedule of each camera. See [7.1.2 Schedule Settings](#) for details.

7.3.3 Motion Based Recording

Motion Based Recording: the system will start motion based recording when the motion object appears in the setup schedule. The setup steps are as follows:

- ① Set the motion based recording schedule of each camera. See [7.1.2 Schedule Settings](#) for details.
- ② Enable the motion and set the motion area of each camera. See [11.2 Motion Alarm](#) for details.

The camera will start motion based recording once you finish the above settings.

7.3.4 Sensor Based Recording

- ① Set the sensor based recording schedule of each camera. See [7.1.2 Schedule Settings](#) for details.
- ② Set the NO/NC type of the sensor, enable the sensor alarm and then check and configure the “Record”. See [11.1 Sensor Alarm](#) for details.

7.3.5 AI Event Recording

- ① Set the intelligence recording schedule of each IP camera. See [7.1.2 Schedule Settings](#) for details.
- ② Enable the intelligence detection (object detection, exception, line crossing, intrusion or face detection) and draw alert surface or warning area of each IP camera. See [9 AI Event Management](#) for details.

The camera will start AI recording once you finish the above settings. This function is only available for some IPCs.

7.4 Disk

7.4.1 Disk Management

The HDD can be plugged in or pulled out when the NVR is on. When the HDD is in abnormal status, the abnormal information will be prompted on the screen (such as “No HDD”, “Only read”, “Unformatted”, “The HDD is unavailable”, etc.)

➤ Disk Management

Click Start→Settings→Disk→Disk Management to go to disk management interface. You can view the NVR’s disk number and disk status and so on in the interface. Click “Format” to format the HDD.

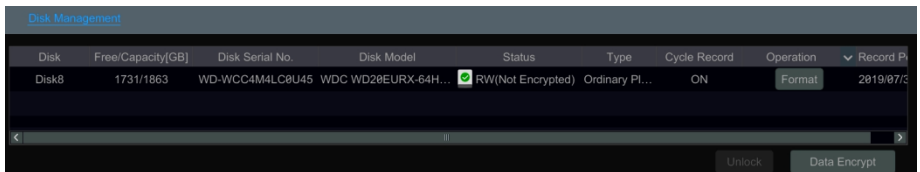

Data Encryption:

- ① Click “Data Encrypt”.
- ② Enter the username and password used to log in the NVR. This username and password shall have the permission of disk management.
- ③ Check the disk you want to encrypt and then enter the password.

After you encrypt the data of a disk, this disk cannot be read by other NVRs unless it is unlocked.

Data Decryption:

- ① Click “Change Encrypt”.
- ② Enter the username and password used to log in the NVR. This user shall have the permission of disk management.
- ③ Check the disk you want to decrypt and then empty the password.
- ④ Click “Close Encrypt”.

Unlock the disk: when one encrypted disk is transferred from another NVR to this NVR, it will be in locked status. Then you can select this locked disk and click “Unlock”. After you enter the password of its data encryption, its status will be “Read Only”. Now you can read the data of this disk but it cannot be written anything.

Some models may not support RAID function. The settings of RAID are as followings. Please skip the settings of physical disk, array and disk mode if the NVR doesn’t support this function.

➤ RAID

① Enable RAID

(Go to Start→Settings→Disk→Disk Mode)

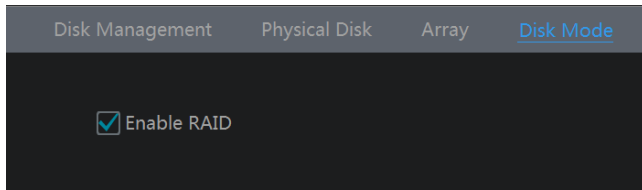

② Create an array. (Go to Start→Settings→Disk→Physical Disk)

a. Click “Physical Disk” tab and then click “Create an array”.

b. Enter the user name and password which has the authority of Disk Management. If you don't have one, you can use the user name and password that you login system (the default username: admin).

c. Enter array name and select array type (like RAID5).

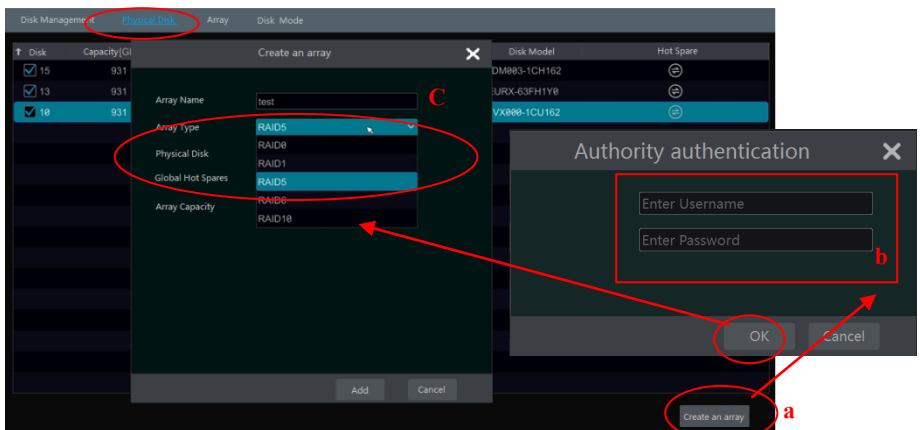



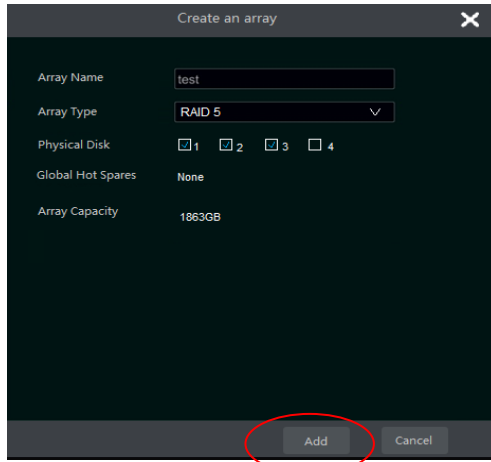

d. Select physical disk.

If you have 16 disks, please check 15 disks. The remaining one should be set to a hot spare. If higher data security is needed, you can decrease physic disks and increase hot spare disks. Please set them as needed.



e. Select a hot spare. In the physical disk interface, select the disk that is not in the array and click  as shown in the following pictures.

Disk	Capacity[GB]	Array	Type	Status	Disk Model	Hot Spare
1	931	test	Array disk	Normal	xxxxx	
2	931	test	Array disk	Normal	xxxxx	
3	931	test	Array disk	Normal	xxxxx	
4	931		Ordinary plate	Normal	xxxxx	

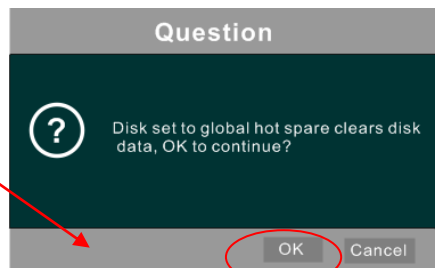
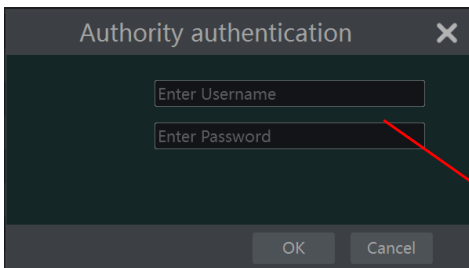

● RAID Rebuilding

If one of your disks is broken, the disk indicator on the front panel will turn red. Of course, a warning tip will pop up if the relevant HDD exception alarm is set. You need to rebuild the RAID after you replace the broken disk with a new one.

Disk Management		Physical Disk	Array	Disk Mode			
No.	Name	Capacity[GB]	Physical Disk	Hot Spare Position	Status	Type	Rebuild
1	test	1862	2 3	4	Downgrade	RAID5	

Click the above circled icon and then select the physical disk to rebuild.

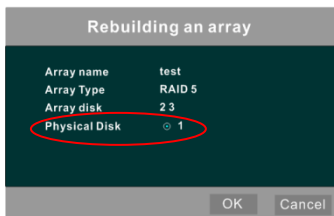

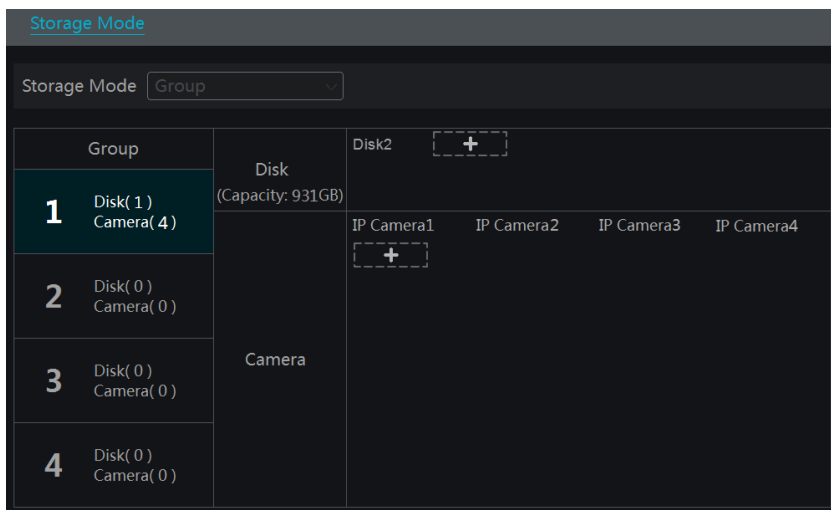

7.4.2 Storage Mode Configuration

Click Start→Settings→Disk→Storage Mode to go to the interface as shown below.





For example, there are all four disk groups. By using disk group, you can correspond the camera to disk (the record data of the camera in the group will be stored into the disks in the same group). The NVR with e-SATA interface supports e-SATA recording.

The added disks and cameras will be added into group one automatically. The disks and cameras in the groups can be deleted except group one (select a disk group and then click  on the top right corner of the added disk or camera to delete it from the group). The deleted disks and cameras will be moved into group one automatically.

Each group can add the disks and cameras from other groups. Each disk and camera can only be added into one group. Select a disk group and then click  in the disk or camera row to pop up a window. Check the disks or cameras in the window and then click “Add”.

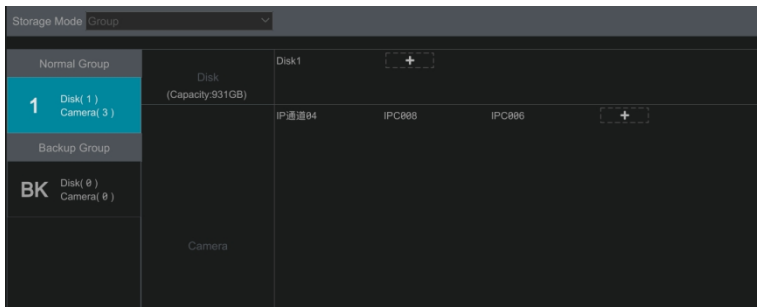
For the model with 2 or 4 HDD slots, BK group can be added as shown below.



Click  to add the backup HDD. After account verification, select a HDD and then this HDD will be removed from the normal group to the backup group. Simultaneously, it will be formatted. Please back up all data of this HDD in advance when you want to remove it to the backup group.

You can add cameras to this HDD. The added cameras can exist and be recorded both in one HDD of the normal group and the backup group.

Note: Each HDD only can exist in one group.

7.4.3 View Disk and S.M.A.R.T. Information

Click Start→Settings→Disk→View Disk Information to view the HDD information; click “S.M.A.R.T. Information” to view the working status of the HDD. Refer to the picture below.

ID	Attibution	Value	Worst Value	Threshold	Raw Value	Status
0x01	Read Error Rate	100	100	62	0	Normal
0x02	Throughput Performance	100	100	40	0	Normal
0x03	Spin-Up Time	234	234	33	1	Normal
0x04	Start/Stop Count	100	100	0	96	Normal
0x05	Reallocated Sector Count	100	100	5	0	Normal
0x07	Seek Error Rate	100	100	67	0	Normal
0x08	Seek Time Performance	100	100	40	0	Normal
0x09	Power-On Hours	99	99	0	724	Normal
0x0a	Spin Retry Count	100	100	60	0	Normal
0x0c	Power Cycle Count	100	100	0	93	Normal
0x0f	G-sense Error Rate	100	100	0	0	Normal
0xc0	Power-off Retract Count	100	100	0	58	Normal
0xc1	Load Cycle Count	100	100	0	8815	Normal
0xc2	Temperature	187	187	0	1638432	Normal
0xc4	Reallocation Event Count	100	100	0	0	Normal
0xc5	Current Pending Sector Count	100	100	0	0	Normal
0xc6	Uncorrectable Sector Count	100	100	0	0	Normal
0xc7	UltraDMA CRC Error Count	200	200	0	0	Normal
0xdf	Load/Unload Retry Count	100	100	0	0	Normal

In addition, you can view the plugging-in or pulling-out details of the HDD from the logs to

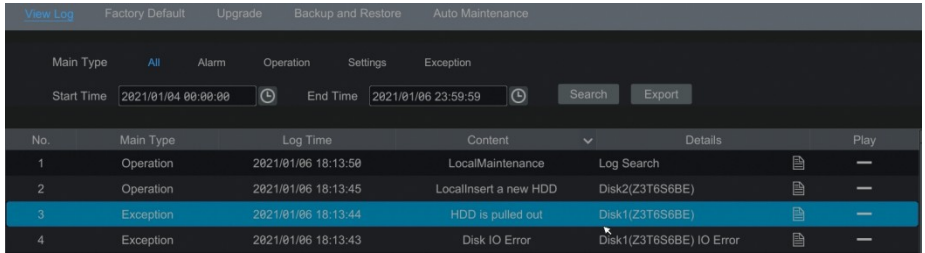

check whether someone moves your HDD or not. Click Start→Settings→System→View Log.



No.	Main Type	Log Time	Content	Details	Play
1	Operation	2021/01/06 18:13:50	LocalMaintenance	Log Search	—
2	Operation	2021/01/06 18:13:45	LocalInsert a new HDD	Disk2(Z3T6S6BE)	—
3	Exception	2021/01/06 18:13:44	HDD is pulled out	Disk1(Z3T6S6BE)	—
4	Exception	2021/01/06 18:13:43	Disk IO Error	Disk1(Z3T6S6BE) IO Error	—



8 Playback & Backup

8.1 Instant Playback

Click  on the tool bar at the bottom of the preview camera window to play back the record (click  on the tool bar at the bottom of the live preview interface to set the default playback time). Refer to the picture below. Drag the playback progress bar to change the playback time. You can also click the right-click menu “Instant Playback” in the camera window and then set the instant playback time to play back the record.



8.2 Playback Interface Introduction

Click  on the tool bar at the bottom of the live preview interface or click Start→Playback to go to the playback interface as shown below (click  on the tool bar at the bottom of the live preview interface to set the default playback time).



















On the panel on the right you will see the channel number and the recorded data coded by color. The bar that runs across them represents the playback time being viewed. You can move this bar around to export, highlight a section of the desired recording, click export and follow the prompts. You can export single or multiple channels at the same time.

The added cameras will playback their records in the playback interface automatically. You can also add the playback camera manually. Click **+** in the playback window to pop up the “Add Camera” window. Check the cameras in the window and then click “Add” to add playback camera. The system supports a maximum of 16 synchronous playback cameras.



The buttons on the tool bar (area ①) at the bottom of the playback interface are introduced in the table below.

Button	Meaning
	Start button. Click it to pop up area ②.
	Full screen button. Click it to show full screen; click it again to exit the full screen.
	Screen display mode button. 1/4/9/16 screen display mode can be selected (depending on models); in addition, the playback channel will be switched by continuous selection of the same screen display mode, for example, after selecting 1-screen display mode, click this mode again and then the current playback channel will switch to the next playback channel.
	OSD ON button. Click it to enable OSD; click it again to disable OSD.
	Quick channel selection button
	Stop button.
	Rewind button. Click it to play video backward.



Button	Meaning
	Play button. Click it to play video forward.
	Pause button.
	Slow Play button. Click it to decrease the playing speed.
	Fast Play button. Click it to increase the playing speed.
	Previous frame button. It works only when the forward playing is paused in single screen mode.
	Next frame button. It works only when the forward playing is paused in single screen mode.
	Click  to step backward 30s and click  to step forward 30s.
	Click it to enter the smart playback interface
	Event list/tag button. Click it to view the event record of manual/schedule/sensor/ motion and the tag information.
	Watermark button. Click it to enable watermark; click it again to disable watermark.
	Open/close POS information.
	 Backup button. Drag the mouse on the time scale to select the time periods and cameras, and then click the button to back up the record.  Backup status button. Click it to view the backup status.
	Back button. Click it to return.









Note: Some models may not support face search and face smart playback.

Introduction of area ②:











Button	Meaning
 Intelligent Analytics	Click it to go to the intelligent analytics interface.
 Search and Backup	Click it to go to record search and backup interface; see 8.4 Record Search, Playback & Backup for details.
 Live Display	Click it to go to live preview interface; see Chapter 5 Live View Introduction for details.

Click on the playback window to show the tool bar as shown in area ③; right click on the window to show the menu list. The tool bar and menu list are introduced in the table below.

Button	Menu List	Meaning
	--	Move tool. Click it to move the tool bar anywhere.
	Enable Audio	Click it to enable audio. You can listen to the camera audio by enabling audio.
	Snap	Click it to snap.



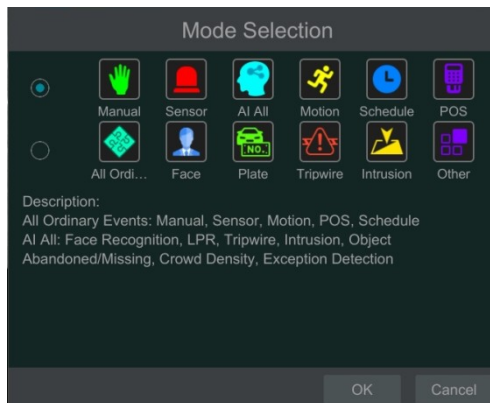

	Zoom In	Click it to go to the zoom in interface. The zoom in interface is similar to that of the camera window in the live preview interface. Click  to pause the record playing; click  to play the record. When the record is paused in forward playing mode, you can click  to view the previous frame and click  to view the next frame.
	Add Tag	Click it to add tag. You can play back the record by searching the added tag. Click it and then enter the tag name in the popup window. Click “Add” to add tag.
	Switch Camera	Click it to switch the playback camera. Click it and then check the camera in the popup window. Click “OK” to change the camera.
	Close Camera	Click it to close the playback camera.

Introduction of area ④:

Click  to set the date; click  to set the time and then the playback camera will play the record from the time you set. You can check the record type as required for record playback; first you should click  on the tool bar at the bottom of the interface to clear all the playback camera, then check the record type (: manual record; : sensor based record; : motion based record; : schedule record; : AI record; : POS record, if you want view the detailed smart playback icons, click  to switch, as shown below). Finally, click  in the playback window to add camera for playback (the record time scale will show the record data of the checked record type only after the above operations).



Introduction of the record time scale (area ⑤):

A tool bar will appear after moving the mouse to the record time scale. Click  /  to zoom the timeline; click  to recover the timeline to 24 hours' ratio. Drag the timeline or slide the scroll wheel of the mouse on the time scale to show the hidden time on the top or bottom of the timeline. You can also click  to show the hidden time on the top of the timeline or click  to show the hidden time on the bottom of the timeline. Drag the slider at the bottom of the time scale to show the hidden playback cameras.

The record time scale shows different record types with different colors. The green block stands for manual record, red block stands for sensor based record, yellow block stands for motion based record, blue block stands for schedule record and cyan block stands for intelligence record. Click the record block to set the time and then the playback camera will play the record from the time you set.

Backup Introduction:

Insert the storage device into the device. Drag the color block on the time scale to select the backup area and then right click the area or click  to pop up a backup information window. Click the “Backup” button in the window to pop up the backup window. Select the device, backup path and backup format and then click the “Backup” button.

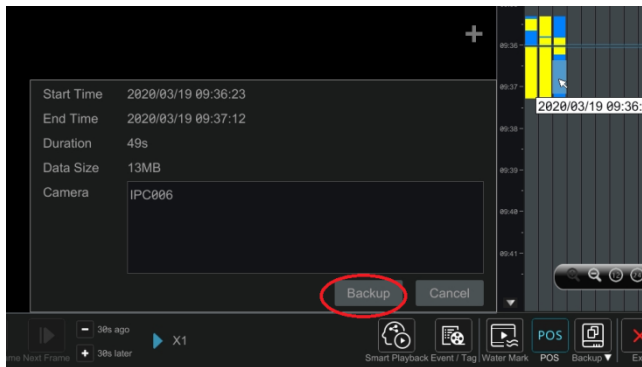

In the backup window, you can select backup path and format. Then click “Backup”. Please select “Encryption” or “No Encryption” as needed. After that, click “OK”.

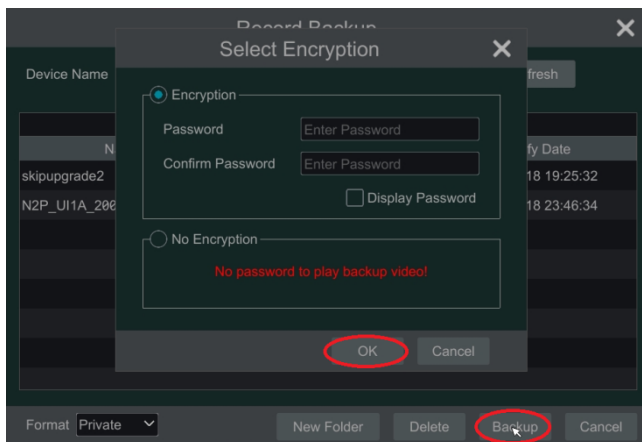





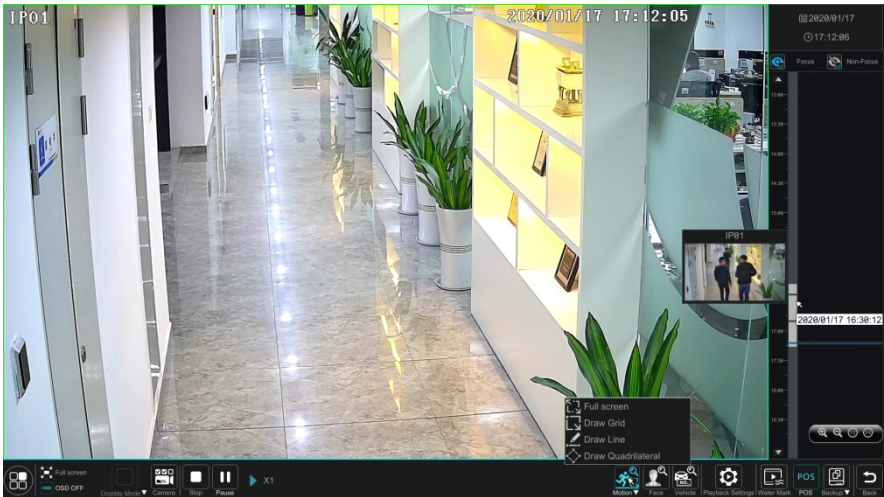



8.3 Smart Playback

In the playback interface, click  to go to the smart playback interface as shown below.



The descriptions of buttons in the smart playback interface

Button		Description
		Full screen motion button.
		Draw grid. You can search the record of motion detection in the pre-defined area.
		Draw line. You can search the record of crossing the line after drawing the line.
		Draw quadrilateral. You can search the record in this quadrilateral after drawing it.
	Search by face	
	Search by license plate number	
	Playback settings button	
	Return button. Click to return to the previous interface.	

8.3.1 Smart Playback Settings

Click  to set the speed of non-interest video (Please skip this one if you click “Skip non-interest video”), “Speed of interest video” and “Intrusion percentage”. You can disable “Non-Focus” to view the video you interest in the right corner of the smart playback interface.

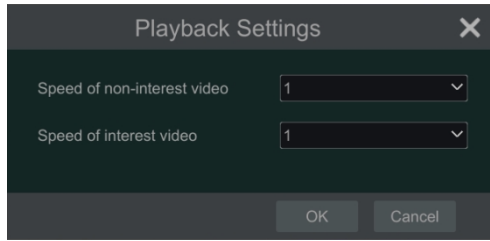

8.3.2 Smart Playback Based on Motion Detection

- **Smart Playback by Drawing Grid**

Click  and draw a rectangle in the desired area. Then the system will automatically search the record files of this area. The cyan blocks indicate that there are intelligent recording files. Move the cursor to such block and click to play the record.

- **Smart Playback by Drawing Line**

Click  and draw a line in the desired area. Then the system will automatically search the record files about crossing this line. The cyan blocks indicate that there are intelligent recording files. Move the cursor to such block and click to play the record.



- **Smart Playback by Drawing Quadrilateral**

Click  and draw a quadrangle in the desired area. Then the system will automatically search the record files of this area. The cyan blocks indicate that there are intelligent recording files. Move the cursor to such block and click to play the record.



8.3.3 Smart Playback by Face Search

Before starting this function, the face recognition function shall be enabled. Please see Face Recognition for details. If your device doesn't support such function, please skip the following instructions.

- ① In the smart playback interface, click  to pop up the following window.

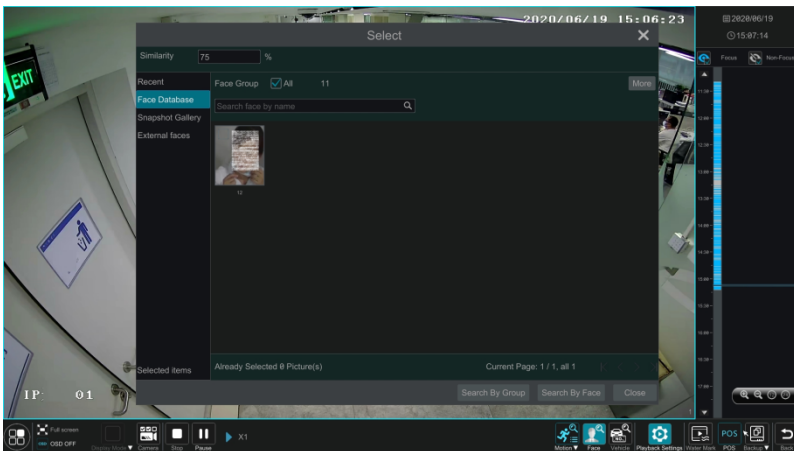

- ① Set similarity. The higher the sensitivity value is, the lower the searching accuracy is, and vice versa.
- ② Select targets. You can select targets from recent, face database, snapshot gallery or external faces.
- ③ Select search mode. There are two search modes: search by group and search by face.
Search by group: Choose “Face Database” and then click “More” to choose one or more groups.

Move the cursor to the time block where the record exists and click to play those records.

8.3.4 Smart Search by License Plate

Before starting smart search by plates, please add ANPR cameras first and enable the LPR function. Please refer to License Plate Recognition for details.

Click  button to go to the following interface.

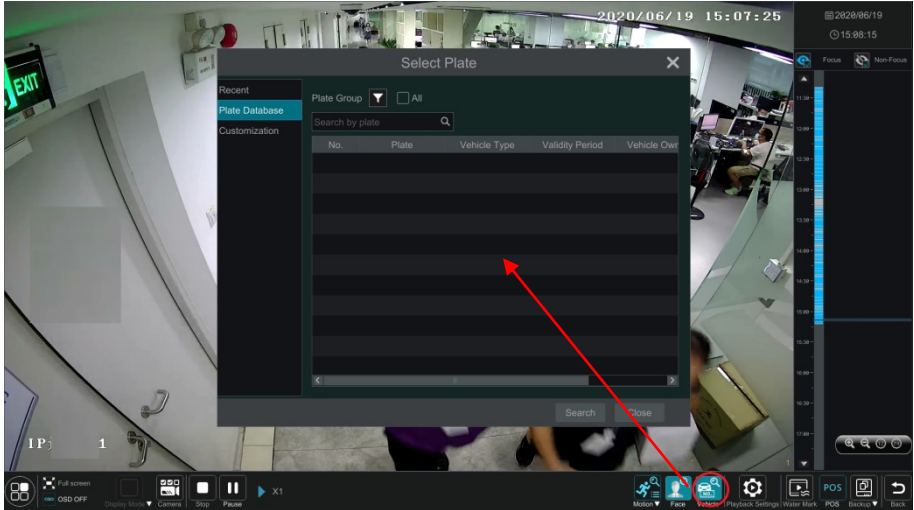

Select the plate from “Recent”, “Plate Database” or “Customization” and then click “Search” to search recorded files and play. Here we take an example of searching plate from “Plate Database”.

Click  to choose a group. Then plates will be listed in the table automatically. Click “Search” to play.



8.4 Record Search, Playback & Backup

The record data and the snapped pictures can be backed up through network, USB (U disk or USB mobile HDD) or e-SATA (only available for some models). The file system of the backup devices should be FAT32 format.

8.4.1 Search, Playback & Backup by Time-sliced Image

① Click Start→Search and Backup→By Time-sliced Image to go to “By Time-sliced Image” tab. There are two view modes: by time and by camera. In the time view mode, a maximum of 64 camera thumbnails can be shown. If the camera thumbnail number is more than 64, the cameras will be listed directly by their camera name, not the thumbnail. A maximum of 196 camera names can be listed. If the camera name number is more than 196, the time view mode will be disabled and the camera view mode will be available only.

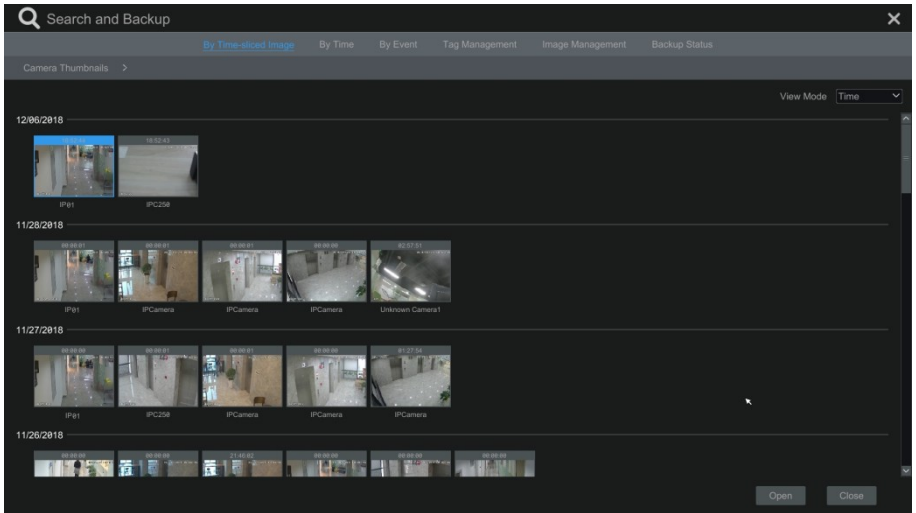

- ② Select one camera in the interface and then click the “Open” button.
- ③ Click the image box to play the record in the small playback box on the left side of the interface (the box which has image inside indicates that the record data exist).
- ④ Refer to the picture below. Drag the color blocks on the time scale to select the record data and then click the “Backup” button to pop up the “Record Backup” window as shown below. Select the device name, backup format and path and then click the “Backup” button to start the backup.

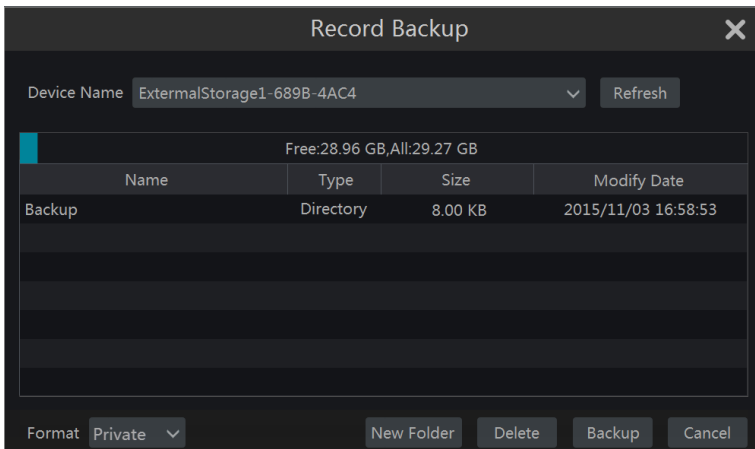

Note: If you back up the record in private format, the system will back up a RPAS player to USB device automatically. The private format record can be played by RPAS player only.

- ⑤ Click “Playback” to play the record in the playback interface (refer to [8.2 Playback Interface Introduction](#) for details). Click “Close” to close the interface.

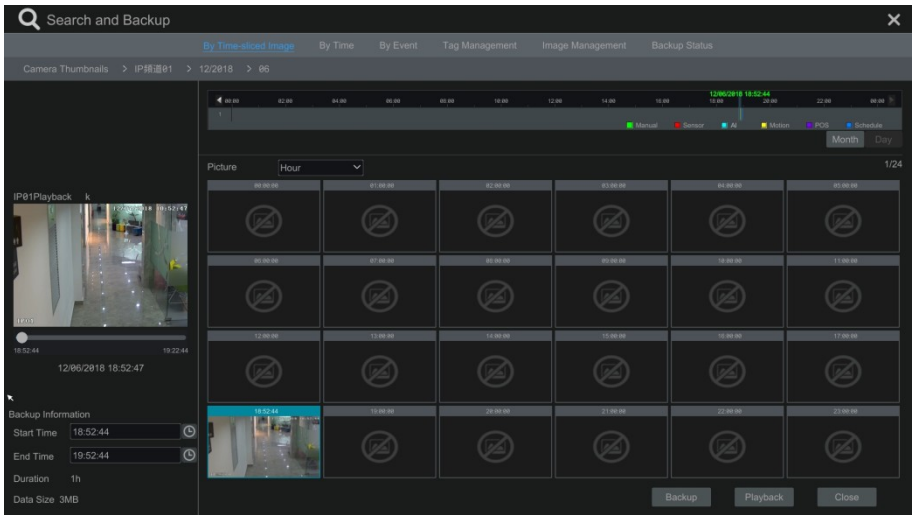

Time Slice Mode Selecting:

Method One: Click “Year”, “Month” or “Day” button under the record time scale to select the time slice mode. In “Day” mode, click ◀ / ▶ on the left/right side of the time scale to view the record of the last/next day; click “Minute” in the “Picture” option under the time scale to select “Minute” mode (in “Minute” mode, click the time scale to change the time of the 60 display windows) and click “Hour” to select “Hour” mode.

Method Two: Click ▶ beside “Camera Thumbnail” on the left top corner of the interface to select the time slice mode.

Method Three: Right-click the mouse on any area of the time-sliced interface to go back to the upper interface.

8.4.2 Search, Playback & Backup by Time

- ① Click Start→Search and Backup→By Time to go to “By Time” tab as shown below.
- ② Click + on the bottom of the interface to add playback camera. A maximum of 16 cameras can be added for playback. Click “Modify” on the top right corner of the camera window to change the camera and click “Clear” to remove the camera.
- ③ Click the camera window to play the record in the small playback box on the left side of the interface. You can set the date on the top left of the interface, check the event type as required and click the time scale or click ⌚ under the time scale to set the time. The camera window will play the record according to the time and event type you set.
- ④ Drag the color blocks on the time scale to select the record data (or click “Set Backup

Time” on the bottom left corner of the interface to set the backup start time and end time) and then click “Backup” for record backup. Click “Playback” to play the record in the playback interface.

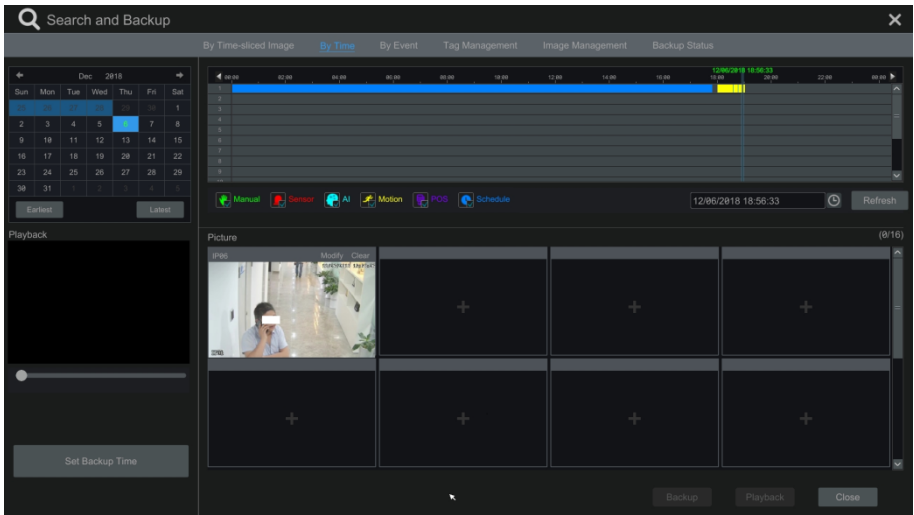



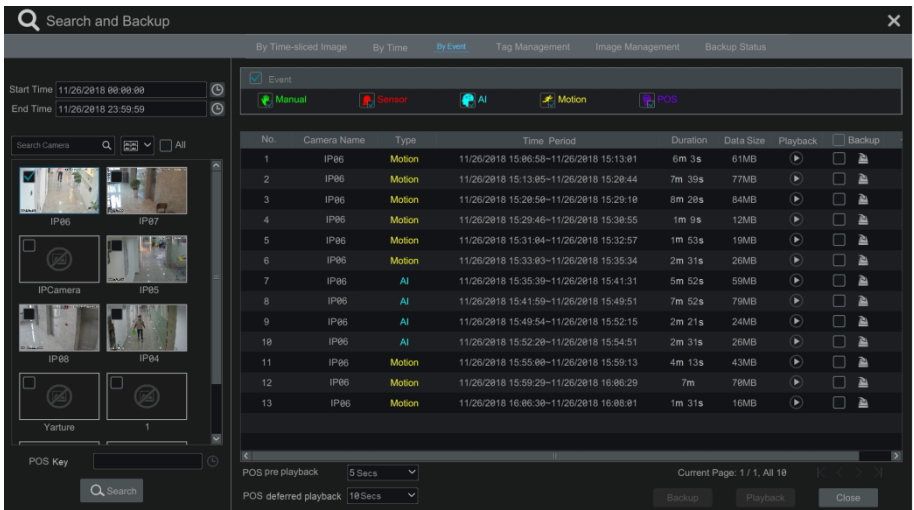

8.4.3 Search, Playback & Backup by Event

Some models may support searching POS event.

- ① Click Start→Search and Backup→By Event to go to “By Event” tab as shown below.



- ② Check the event type in the interface as required.



- ③ Click  to set the start time and end time on the top left of the interface.
- ④ Check cameras on the left side of the interface or check “All” to select all the cameras and then click  to search the record. The searched record will be displayed in the list.
- ⑤ Click  in the list to play back the record in the popup window. Click  to backup one record data or check multiple record data in the list and then click “Backup” for record batch backup.
- ⑥ Select one record data in the list and then click “Playback” to play the record in the playback interface.

8.4.4 Search & Playback by Tag

Only if you add the tags can you play the record by tag search. Click Start→Playback to go to the playback interface and then click  on the bottom of the camera window to add tag when you want to mark the playback time point of the selected camera.

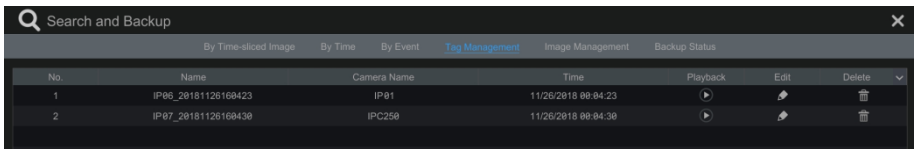
Click Start→Search and Backup→Tag Management to go to “Tag Management” tab.









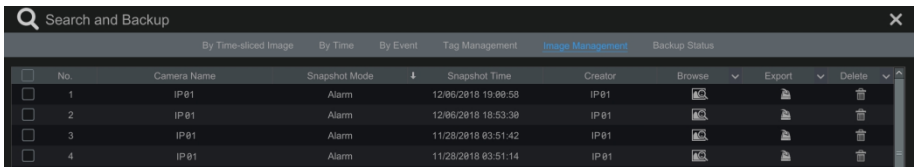

Click  in the interface to play the record. Click  to edit the tag name. Click  to delete the tag.

8.4.5 Image Management

Click Start→Search and Backup→Image Management to go to “Image Management” tab. The system will display all the snapped images automatically in the list.



Click  to delete the image. Click  to pop up the “Export” window. Select the device name and save path in the window and then click the “Save” button.

Click  to pop up the “View Image” window. Click  to export the image. Click  to view the previous image; click  to view the next image; click  to delete the image; click  to play all the images.

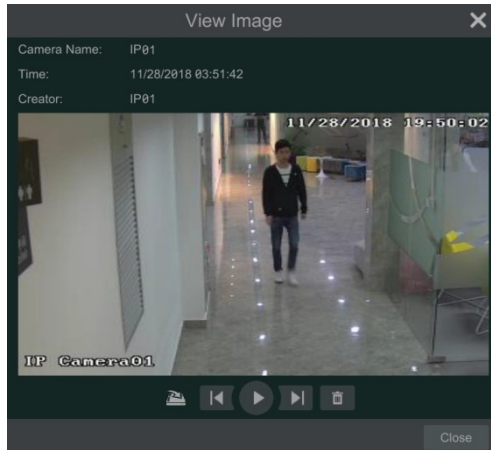

8.4.6 View Backup Status

Click Start→Search and Backup→Backup Status or click  on the tool bar at the bottom of the playback interface to view the backup status.

9 AI Event Management

9.1 Face Recognition

Only some models support alarm based on face comparison. If your device doesn't support face recognition function, please skip the face database and face recognition instructions.

Please set face recognition function according to the following procedures for the first time.

Set face detection and alarm linkage → Add face group → Add faces to the face group → Enable and set successful recognition (or stranger) → Set successful recognition (or stranger) alarm linkage

9.1.1 Face Detection Settings

Face Detection: Alarms will be triggered if someone intrudes into the pre-defined alarm areas.

① Click Start→Settings→AI/Event→AI Event→Face Recognition→ Detection to go to the following interface.

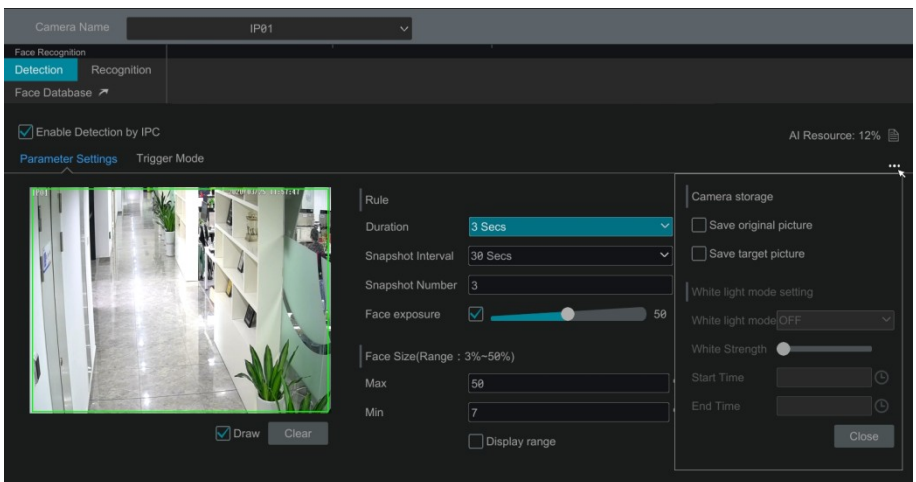

② Select the camera, check “Enable Detection by IPC” and set the duration.

Note: Some models may support face detection by NVR. For these models, the camera without AI function also can be added and used to detect faces through NVR. But if face detection by NVR is enabled for one camera (without AI), the people/vehicle perimeter detection cannot be enabled simultaneously, and vice-versa.

- ③ Set the snapshot interval and snapshot number. The snapshot interval refers to the time interval that the camera captures the same face during its continuous tracking period. The snapshot number refers to the picture number of the same face captured during its continuous tracking period (For example: the snapshot interval is set to “30 seconds” and the snapshot number is set to “3”; then the camera will capture the same face once every 30 seconds and it will capture this face 3 times at most during its continuous tracking period).
- ④ Enable face match exposure as need. When the brightness of the captured face is not enough, it can be enabled. (Only some IPCs support this function)
- ⑤ Set the alarm area. Click “Draw” and then drag the mouse to draw a detection area. Click “Clear” to delete the alarm area. Then set the detectable face size by defining the maximum value and the minimum value (The default size range of a single face image occupies from 3% to 50% of the entire image).

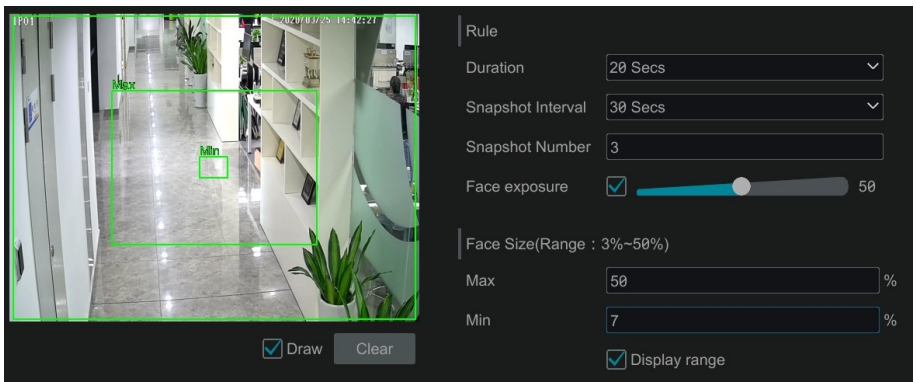

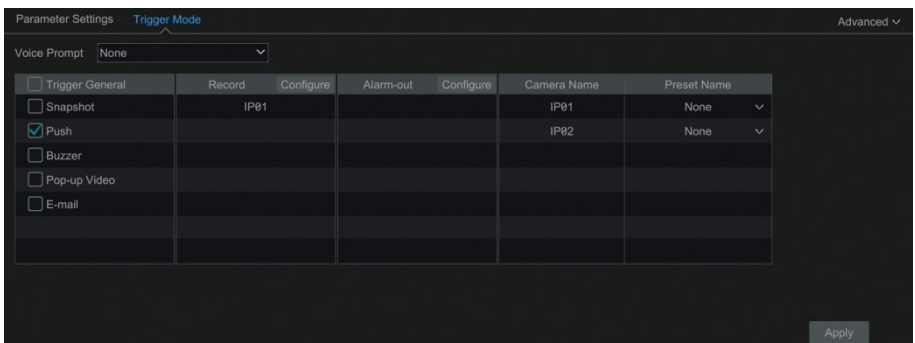

- ⑥ Enable “Save Source Information” or/and “Save Face Information” as needed. If enabled, the system will automatically save the corresponding images on the SD card. For the models with LED light, white light mode also can be set.
- ⑦ Click “Apply” to save the settings.
- ⑧ Click “Trigger Mode” to go to face detection alarm linkage setting interface:



Face Detection Alarm Linkage Configuration:

- Trigger “Voice Prompt”, “Record”, “Snapshot”, “Push”, “Alarm-out”, “Preset”, “Buzzer”, “Pop-up Video” and “E-mail” as needed.

Voice Prompt: Please upload the audio file in local audio alarm interface first (click Start→Settings→AI/Event→Event Notification→Audio). Please see [11.5.6 Audio](#) for details.

Record: Click the “Configure” button to pop up the window. Select camera on the left side and then click  to set the camera as the trigger camera. Select trigger camera on the right side and then click  to cancel the trigger camera. Click “OK” to save the settings. The trigger cameras will record automatically when faces are detected.

Alarm-out: Click the “Configure” button to pop up the window. Then the “Trigger Alarm-out” window will pop up automatically. Configure the trigger alarm-out in the window. The system will trigger the alarm-out automatically when faces are detected. You need to set the delay time and the schedule of the alarm outputs. See [11.5.1 Alarm-out](#) for details.

Preset: Click  and then select the preset for each camera. To add presets, please see [6.2 Preset Setting](#) for details.

Snapshot: check it. The current camera will capture images automatically when faces are detected.

Push: If it is enabled, the system will send messages when faces are detected.

Buzzer: if it is enabled, the system will begin to buzz when faces are detected. To set the delay time of the buzzer, please see [11.5.4 Buzzer](#) for details.

Pop-up Video: if it is enabled, the system will pop up the corresponding video automatically when faces are detected. To set the duration time of the video, please see [11.5.3 Display](#) for details.

E-mail: if it is enabled, the system will send an e-mail when faces are detected. In the meanwhile, it will attach the captured face picture and the original picture so that you can view the whole scene when the alarm occurs. Before you enable the email, please configure the recipient’s e-mail address first (see [13.1.5 E-mail Configuration](#) for details).

Enable “IPC_Audio” or “IPC_Light” as needed (only some IPCs support these two functions). To set the IPC voice and its times and volume, please refer to [11.5.6 Audio](#) for details. To set the light flashing time and frequency of the IPC, please refer to [11.5.7 Light](#) for details.

- ⑨ Click “Apply” to save the settings.

9.1.2 Face Database Management

- ① Click Start→Settings→AI/Event→AI Event→Face Recognition→Face Database to go to the following interface as shown below.

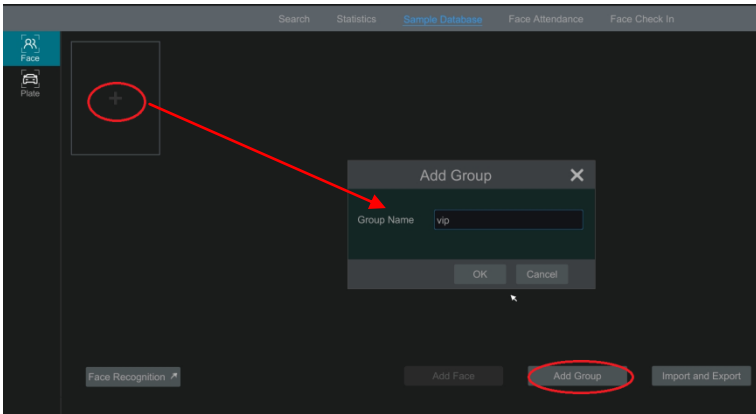

For the first time, you can click “+” or “Add Group” to add groups.

② To add targets for each group.

- Select a list and then click  to expand the list as shown below.

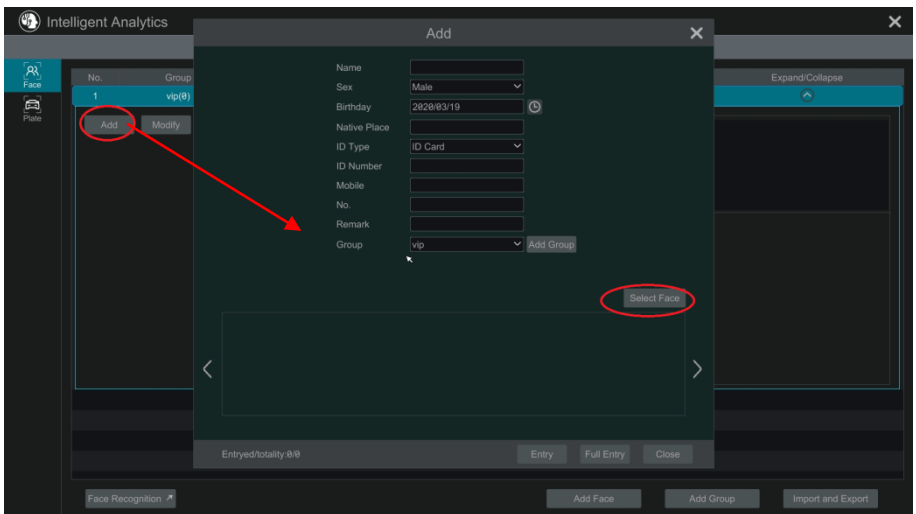

- Click “Add” and then click “Select Face” to add face images. You can add faces from snapshot gallery or external faces.

Adding faces from snapshot gallery: Select search time or self define the search time and then click “Search” to search target faces. Then select the desired faces and click “Select”.

Note: The picture marked with a green icon can be added to the face database.

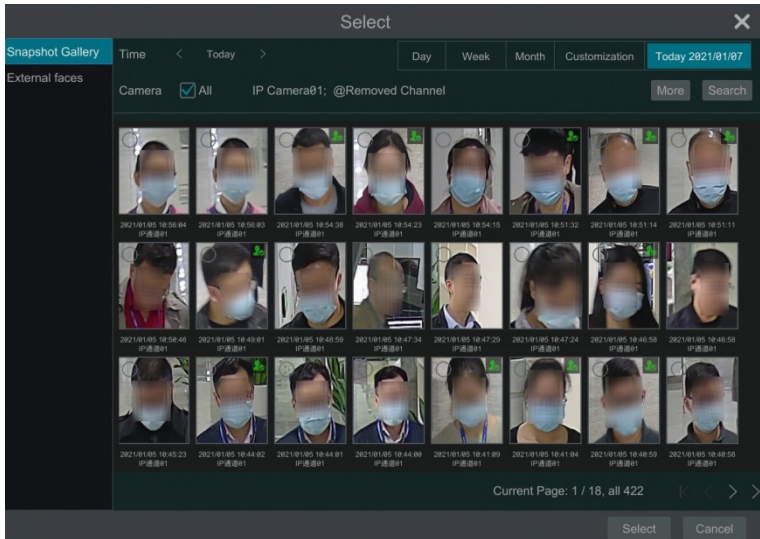

Add external faces

Save the face pictures in your USB storage device and then insert the USB storage device into the USB port of the NVR.

Go to the face database interface. Click to expand the group and then click “Add”. Select “External faces” to select face pictures. You can select one face to add or multiple faces to add.

To add multiple faces: a. put face pictures and the description file (.csv or .txt) to one specific folder (please edit the detailed descriptions of these pictures according to the personal information description); b. click “All” to select all face pictures; c. click “Full Entry”.

Note: the added image must be less than 70KB and the image format shall be “.jpg” and “.jpeg”.

- After that, add the corresponding information, like name, gender, birthday, ID number, phone number and so on.

Having saved the target image, click the image and then the detailed information will be listed on the right.

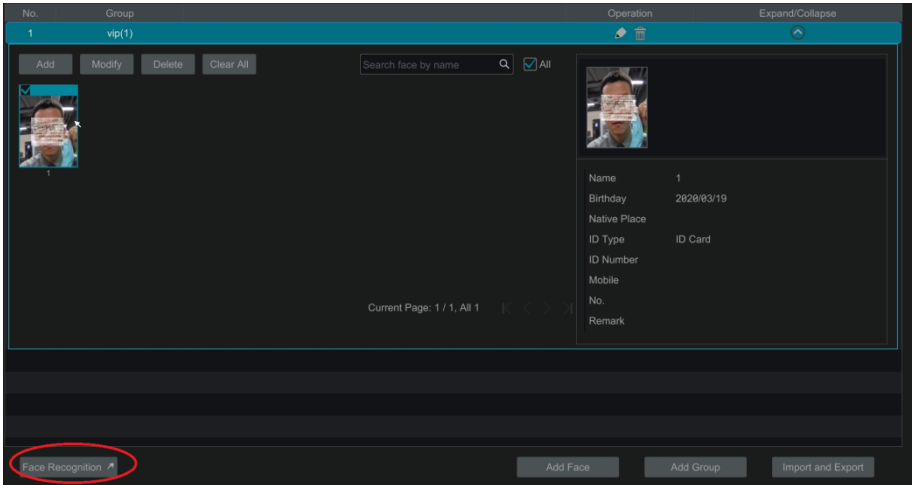

- Import and Export Face database
Insert your mobile storage device into the USB interface of the NVR and then click “Import and Export” to import or export the face database settings.

9.1.3 Face Recognition Settings

After the face database and face pictures are added, click “Face Recognition” to return to the face recognition setting interface. Click the “Recognition” tab to go to the following interface.

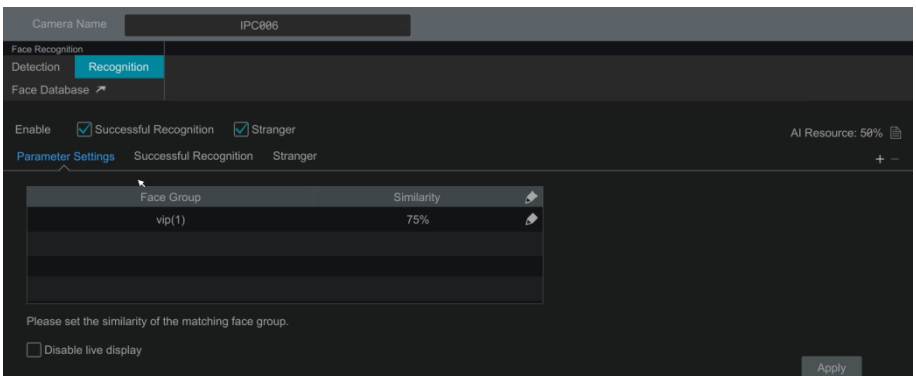

- ① Enable “Successful Recognition” or “Stranger”. Click “Parameter Settings” to set the similarity of the matching face group.
Disable live display: if checked, the live view interface (target detection tab) will not display captured faces in real time.

- ② Set the alarm linkage items of successful recognition.

The screenshot shows the 'Successful Recognition' configuration page. At the top, there are checkboxes for 'Successful Recognition' (checked) and 'Stranger' (unchecked). Below this, there are tabs for 'Parameter Settings', 'Successful Recognition', and 'Stranger'. The 'Successful Recognition' tab is active. The configuration includes a 'Face Group' dropdown set to 'All' with a count of '1', a 'Schedule' dropdown set to '24x7' with a 'Manage' button, and 'Text Prompt' and 'Voice Prompt' fields. The 'Voice Prompt' is set to 'None'. There is an unchecked checkbox for 'Enable alarm output pulse(Access Control)'. Below these settings is a table for alarm linkage items.

<input type="checkbox"/> Trigger General	Record	Configure	Alarm-out	Configure	Snapshot	Configure	Camera Name	Preset Name
<input checked="" type="checkbox"/> Push							IP Camera01	None
<input type="checkbox"/> Buzzer								
<input type="checkbox"/> Pop-up Video								
<input type="checkbox"/> E-mail								
<input type="checkbox"/> Pop-up Message Box								

An 'Apply' button is located at the bottom right of the interface.

- Select one or more face groups and then choose the schedule. Click “Manage” to set the schedule.
 - Set the text prompt and voice prompt. When the captured face is matched successfully, the text will appear on the right of the live view interface and broadcast the audio.
 - Enable alarm output pulse (access control).
 - Trigger record, snapshot, alarm-out, buzzer, push, pop-up video, E-mail and pop-up message box as needed. The alarm linkage settings are similar to the face detection alarm (see [9.1.1 Face Detection Settings](#) for details).
 - Click “Apply” to save the settings.
- ③ Set the stranger alarm linkage items. When the captured face picture doesn't match the face pictures in the face database or their similarity is lower than the set value, the captured person will be regarded as a stranger.

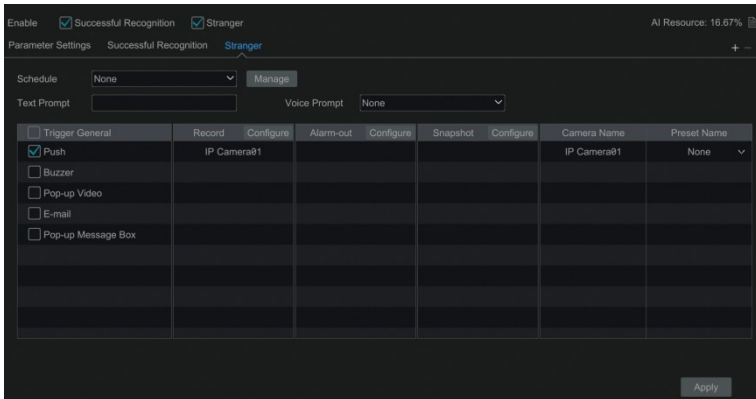

- Configure the schedule
- Set the text prompt and voice prompt. The text will show on the captured picture and the voice will be broadcasted when detecting a stranger.
- Trigger record, snapshot, alarm-out, buzzer, push, pop-up video, E-mail, Preset and pop-up message box as needed. The alarm linkage settings are similar to the face detection alarm (See [9.1.1 Face Detection Settings](#) for details).
- Click “Apply” to save the settings.

④ Click “+” to add more successful recognition tasks. Select the added task and then click “-” to delete it.

9.2 License Plate Recognition

Please add the ANPR camera before you using this function. If your camera doesn’t support this function, please skip the following instruction.

Please set license plate recognition function according to the following procedures for the first time.

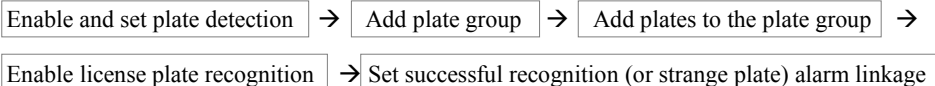

9.2.1 License Plate Detection Settings

Click Start→AI/Event→AI Event→LPR to go to the following interface. Select an ANPR camera and click the “Detection” tab as shown below.

Set the plate size by defining the maximum value and the minimum value (The default size range of a single plate occupies from 5% to 50% of the entire image).

Display range: if enabled, the set maximum detection box and the minimum detection box can be displayed on the left window.

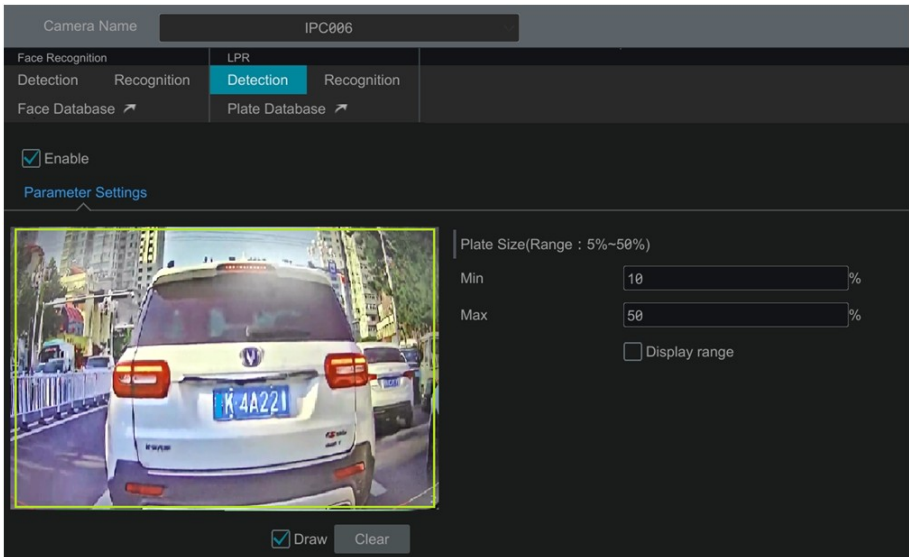

Set the alarm area. Click “Draw” and then drag the mouse to draw a detection area. Click “Clear” to delete the alarm area.

9.2.2 Plate Database Management

In the LPR interface, click the “Plate Database” tab to go to the plate database management interface as shown below.

For the first time, you can click “+” or “Add Group” to add groups.

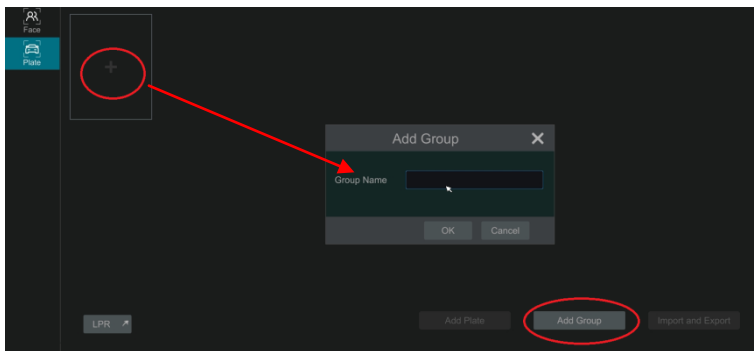

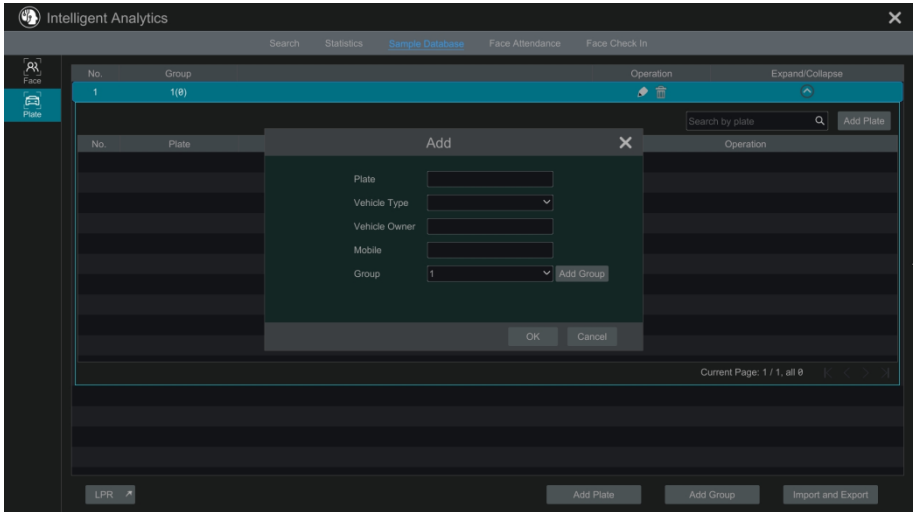

Add plates to each group:

- ① Click  to extend the group. Click “Add Plate” to pop up the following window.



- ② Enter the plate, vehicle owner and mobile phone number.
- ③ Select the vehicle type and group.
- ④ Finally click “OK” to complete.

Select the added plate and then click  to modify its information; click  to delete this plate. The plates can be imported and exported in bulk by clicking “Import and Export”. You can click “Plate Information Description” to view the detailed information about how to import or export the plate list.

9.2.3 License Plate Recognition Settings

- ① In the LPR interface, click the “Recognition” tab. Then enable “Successful Recognition” or “Strange Plate”.

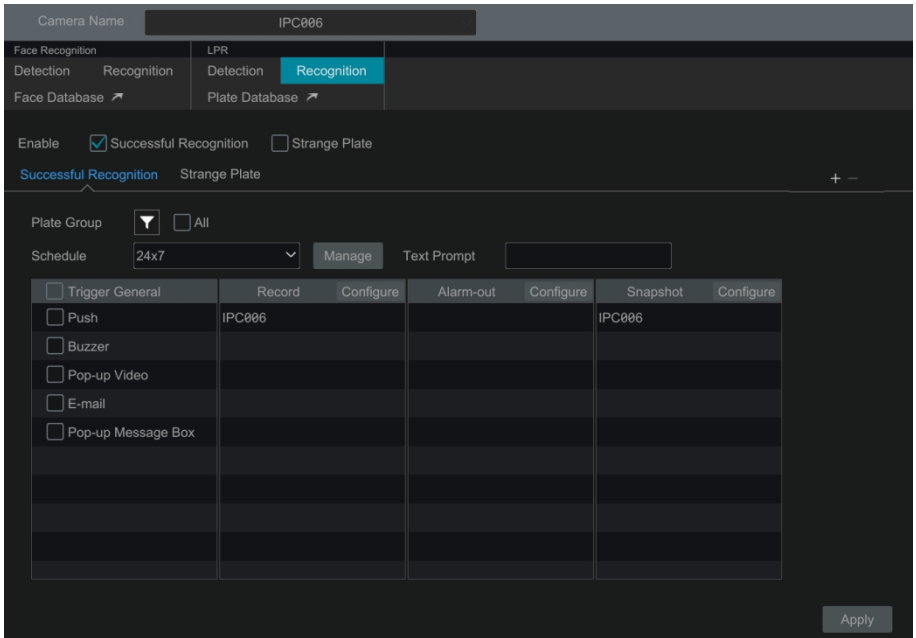

- ② Set the successful recognition alarm linkage.
 - Select one or more plate groups and then choose the schedule. Click “Manage” to set the schedule.
 - Set the text prompt. When the captured plate is matched successfully, the text will appear on the right of the live view interface.
 - Enable alarm output pulse (access control).
 - Trigger record, snapshot, alarm-out, buzzer, push, pop-up video, E-mail and pop-up message box as needed. The alarm linkage settings are similar to the face detection alarm (See [9.1.1 Face Detection Settings](#) for details).
- ③ Set the strange plate alarm linkage. When the captured plate picture doesn’t match the plates in the plate database or their similarity is lower than the set value, the captured plate will be regarded as a strange plate.

9.3 Line Crossing Detection

Tripwire/Line Crossing Detection Configuration:

Alarms will be triggered if the people or vehicles cross the pre-defined alarm line.

- ① Click Start→Settings→AI/Event→AI Event →Line Crossing to go to the following interface.

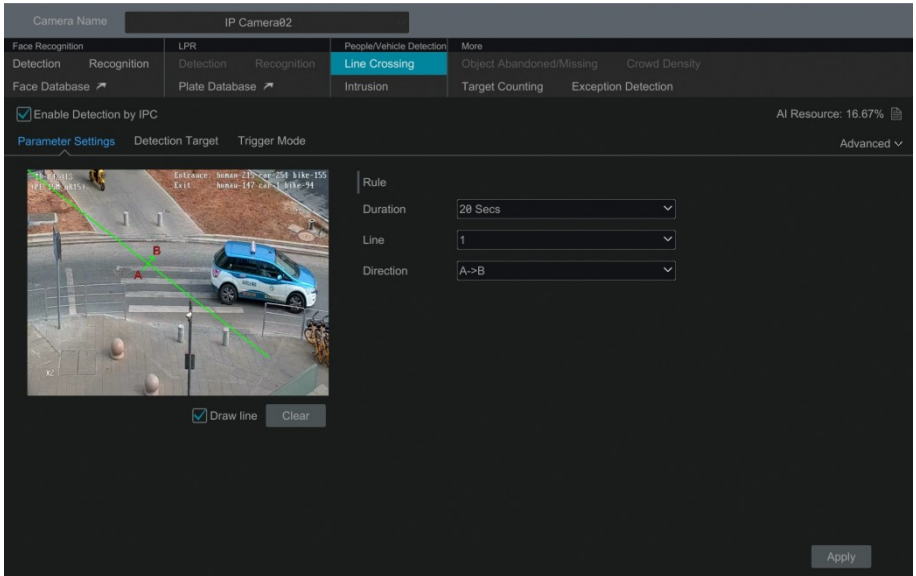

② Select the camera, enable line crossing detection by IPC and set the duration.

Note: Some models may support line crossing detection by NVR.

③ Select the direction.

Direction: A<->B, A->B and A<-B optional. It is the crossing direction of the target that crosses over the alert line.

A<->B: the alarm triggers when the target crosses over the alert line from B to A or from A to B.

A->B: the alarm triggers when the target crosses over the alert line from A to B.

A<-B: the alarm triggers when the target crosses over the alert line from B to A.

④ Draw line. Refer to the interface as shown above. Check “Draw line” and then drag the mouse in the image to draw an alert line. Uncheck the “Draw line” if you finish the drawing. Click the “Clear” to delete the alert line.

⑤ Click “Detection Target” to choose the detection target and the sensitivity. The detection target includes human, motor vehicle and non-motor vehicle. Only some IPCs can detect human or vehicle separately. If the camera doesn’t support this function, please skip this step.

⑥ Click “Advanced” to choose “Save original picture” or “Save target picture” on the SD card of the camera. (If your camera doesn’t support this function, please skip this step).

⑦ Click “Trigger Mode” to configure line crossing alarm linkage items.

- Enable or disable “Record”, “Snapshot”, “Push”, “Alarm-out”, “Preset”, “Buzzer”, “Pop-up Video” and “E-mail”. The alarm linkage settings are the same as the face detection alarm (see [9.1.1 Face Detection Settings](#) for details).

- Enable “IPC_Audio” or “IPC_Light” as needed (only some IPCs support these two functions). To set the IPC voice and its times and volume, please refer to [11.5.6 Audio](#) for

details. To set the light flashing time and frequency of the IPC, please refer to [11.5.7 Light](#) for details.

⑧ Click “Apply” to save the settings.

9.4 Intrusion Detection

Intrusion Detection Configuration:

Alarms will be triggered if the people or vehicles intrude into the pre-defined area.

① Click Start→Settings→AI/Event →AI Event→Intrusion to go to the following interface.

② Select the camera, enable the intrusion detection by IPC and set the duration.

Note: Some models may support line crossing detection by NVR.

③ Select regional activities. “Appear” or “Cross” can be selected (if your camera doesn’t support region entrance/exiting detection, “Cross” will not be enabled). If “Cross” is selected, you can choose the crossing direction.

④ Select the alarm area. Up to 4 alarm areas can be set up.

⑤ Draw the alarm area of the intrusion detection. Refer to the interface as shown below. Check “Draw Area” and then click around the area where you want to set as the alarm area in the image (the alarm area should be a closed area). Uncheck the “Draw Area” if you finish the drawing. Click the “Clear” to delete the alarm area.

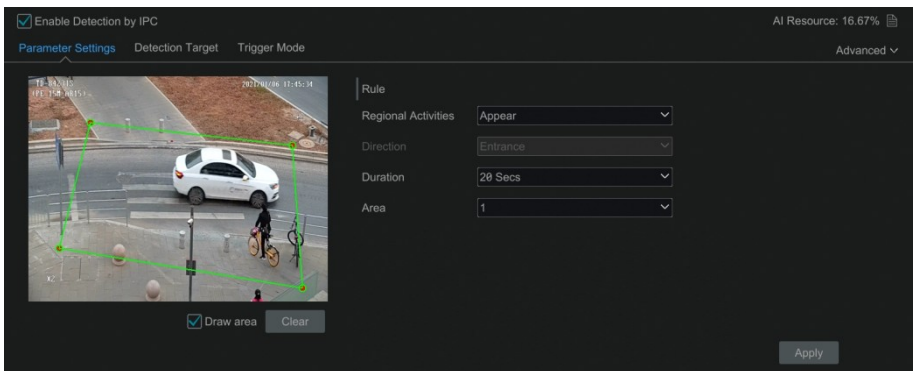

⑥ Click “Detection Target” to choose the detection target and the sensitivity. The detection target includes human, motor vehicle and non-motor vehicle.

⑦ Click “Trigger Mode” to configure intrusion detection alarm linkage items.

- Enable or disable “Record”, “Snapshot”, “Push”, “Alarm-out”, “Preset”, “Buzzer”, “Pop-up Video” and “E-mail”. The alarm linkage settings are the same as the face detection alarm (see [9.1.1 Face Detection Settings](#) for details).

- Enable “IPC_Audio” or “IPC_Light” as needed. (only some IPCs support these two functions). To set the IPC voice and its times and volume, please refer to [11.5.6 Audio](#) for details. To set the light flashing time and frequency of the IPC, please refer to [11.5.7 Light](#) for details.

⑧ Click “Copy To” to copy all settings to other cameras.

- ⑨ Click “Apply” to save the settings.

9.5 Abandoned/Missing Object Detection

① Click Start→Settings→AI/Event→AI Event→Object Abandoned/Missing to go to the following interface.

② Select the camera, enable the object detection and set the duration and detect type. There are two detection types: Abandoned object and missing object.

Abandoned object: Alarms will be triggered if there are articles left in the pre-defined detection area.

Missing object: Alarms will be triggered if there are articles missing in the detection area drew by the users.

③ Select the alarm area and area name. A maximum of 4 alarm areas can be set.

④ Draw the alarm area of the object detection. Refer to the interface as shown above. Check “Draw Area” and then click around the area where you want to set as the alarm area in the image (the alarm area should be a closed area). Uncheck the “Draw Area” if you finish the drawing. Click the “Clear” to delete the alarm area.

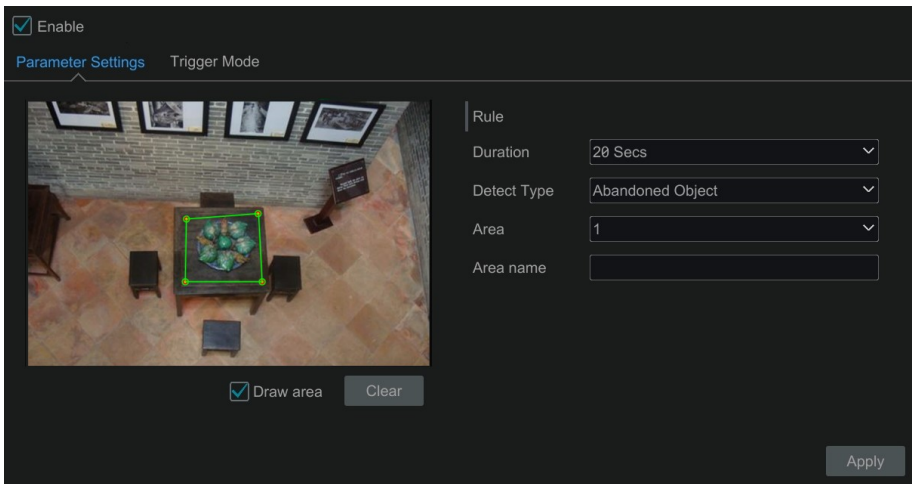

⑤ Click “Trigger Mode” to configure abandoned/missing object detection alarm linkage items. Enable or disable “Record”, “Snapshot”, “Push”, “Alarm-out”, “Preset”, “Buzzer”, “Pop-up Video” and “E-mail”. The alarm linkage settings are the same as the face detection alarm (see [9.1.1 Face Detection Settings](#) for details).

⑥ Click “Apply” to save the settings.

9.6 Crowd Density Detection

Only some IPCs may support this function.

Crowd Density Configuration:

Alarms will be triggered if the crowd density exceeds the set threshold value in the pre-defined area.

① Click Start→Settings→AI/Event→AI Event→Crowd Density to go to the following interface.

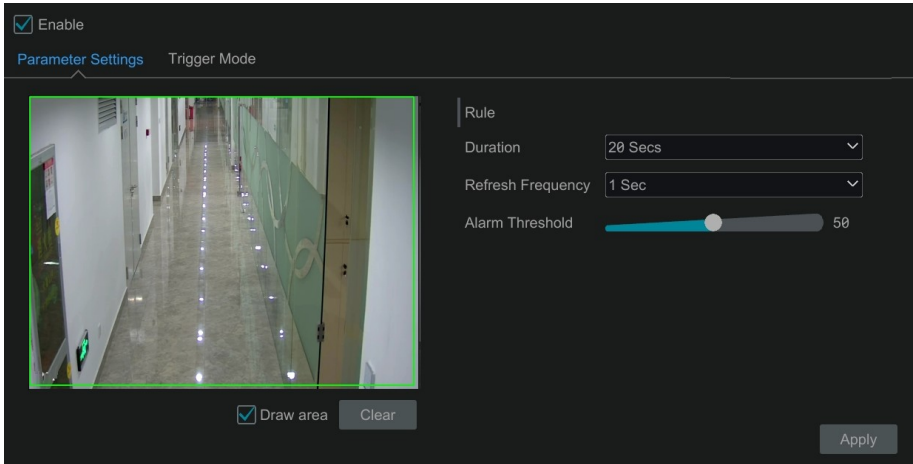

② Select the camera, enable the crowd density detection and set the duration, refresh frequency and alarm threshold.

Refresh Frequency: It refers to the refresh time of the detection result report.

Alarm Threshold: Alarms will be triggered once the percentage of the crowd density in a specified area exceeds the pre-defined threshold value.

③ Select the alarm area. Draw the alarm area of the crowd density detection. Refer to the interface as shown below. Check “Draw Area” and then drag the mouse to draw a rectangle area. Uncheck the “Draw Area” if you finish the drawing. Click the “Clear” to delete the alarm area.

④ Click  to configure crowd density detection alarm linkage items. Enable or disable “Record”, “Snapshot”, “Push”, “Alarm-out”, “Preset”, “Buzzer”, “Pop-up Video” and “E-mail”. The alarm linkage settings are the same as the face detection alarm (see [9.1.1 Face Detection Settings](#) for details).

⑤ Click “Apply” to save the settings.

9.7 Target Counting

Only some IPCs may support this function.

- **People counting in the pre-defined area:**

This function is to calculate the number of people entering or exiting in the detected area on the

video by detecting, tracking and counting the head shapes of people.

Note: Only some specific IPCs may support this function.

① Click Start→Settings→AI/Event→AI Event→Target Counting to go to the following interface.

② Select the camera, enable target counting detection and set the duration, sensitivity, statistic cycle, enter threshold, departure threshold and retention threshold.

Statistic cycle: Always, daily, weekly and monthly are optional.

Manual Reset: The current number of people counting will be cleared and the statistic cycle will restart by clicking “Manual Reset” button.

③ Set the alarm area and entrance direction. Click “Draw Area” and drag the mouse to draw a rectangle area. Drag the rectangle to change its position. Uncheck the “Draw Area” if you finish the drawing. Click “Clear” to clear the area. Click and drag the arrow or the other end of the arrow line to change the people entrance direction.

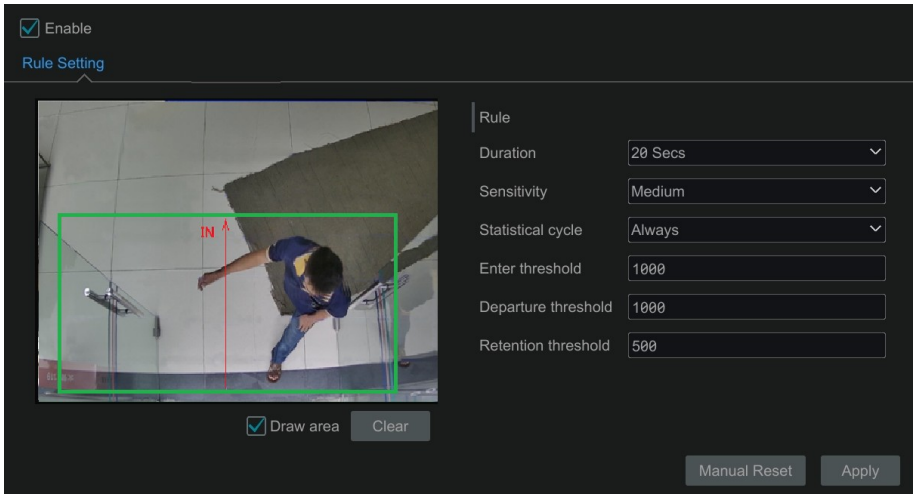

⑤ Click “Apply” to save the settings.

● Human/Motor Vehicle/Non-Motor Vehicle Counting

The information of human/motor vehicle/non-motor vehicle can be calculated and sent by day, by week and by month, so that you can receive and analyze these statistics on time.

Only some IPCs support this function. If your camera doesn't support this function, please skip the following instructions.

① Click Start→Settings→AI/Event→AI Event→Target Counting to go to the following interface.

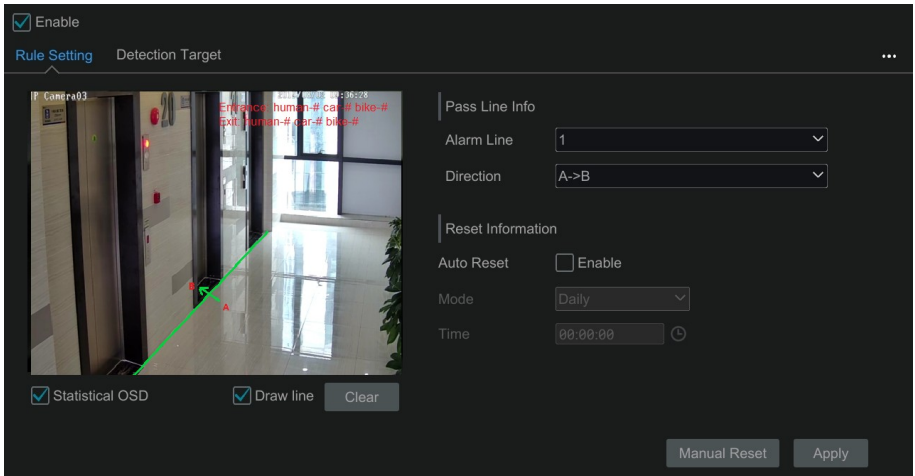

② Enable line crossing counting.

③ Check “Draw line” and then drag the mouse on the small window to draw the crossing line. Uncheck “Draw line” to finish the drawing. Click “Clear” to delete the alert line.

Direction: A->B and A<-B are optional. It is the crossing direction of the target that crosses over the alert line.

④ Check “Statistical OSD”, the statistical information will be displayed on the live view interface.

⑤ Set the reset information. You can set reset information manually or enable “Auto Reset” as needed.

⑥ Click the “Detection Target” tab to set the detection target, including human, motor vehicle and non-motor vehicle.

⑦ Click “Advanced” to pop up the following window. You can select “Save original picture” or “Save target picture”.

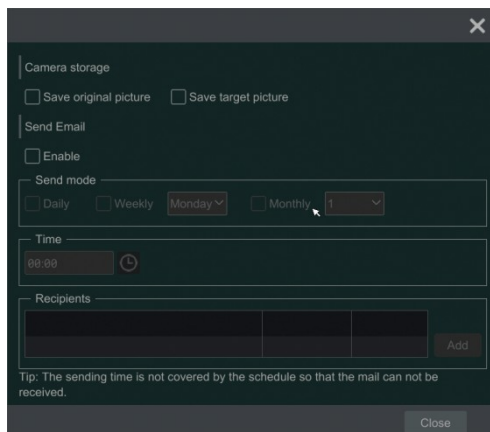

In the above interface, you can send Email to the specified person daily/weekly/monthly regarding the target counting. Click “Add” to add the recipient”, and then enable “Send Email” and select “Send mode” and time.

⑧ Click “Apply” to save the settings.

9.8 Exception Detection

Exception Detection Configuration:

① Click Start→Settings→AI/Event→AI Event→Exception Detection to go to the following interface.

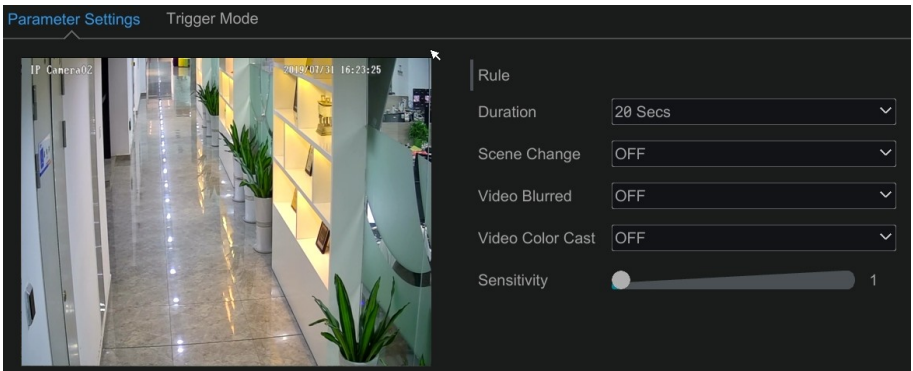

② Select the camera and detection duration and then enable the relevant detection as needed.

Scene Change: Alarms will be triggered if the scene of the monitor video has changed.

Video Blurred: Alarms will be triggered if the video becomes blurry.

Video Color Cast: Alarms will be triggered if the video becomes obscured.

③ Set the sensitivity of the exception detection.

④ Click “Trigger Mode” to configure exception alarm linkage items. Enable or disable “Record”, “Snapshot”, “Push”, “Alarm-out”, “Preset”, “Buzzer”, “Pop-up Video” and “E-mail”. The alarm linkage settings are the same as the face detection alarm (see [9.1.1 Face Detection Settings](#) for details).

⑤ Click “Apply” to save the settings.



10 Intelligent Analytics

10.1 Target Detection View

Only some models support target detection view. If your device doesn't support it, please skip the following instructions.

10.1.1 Human Body/Vehicle Detection View

Only when the camera supports human body/vehicle detection, can you view the real-time captured people or vehicle pictures. The setting steps are as follow:

- ① Enable the Line crossing/Intrusion function of IPCs/NVR, draw the line or area and choose the detection target (see [9.3 Line Crossing Detection](#) and [9.4 Intrusion Detection](#) for details).
- ② Go to live view interface and then click  to go to the target detection interface of this channel. In this interface, you can switch the channel on the top right. You can also click  on the top right corner of the live view interface and then choose the target detection tab to go to the target detection interface of multi-channel as shown below. Click the captured picture on the right of the live interface to see the snapshot detailed information, such as snapshot time, camera, event type and target type.

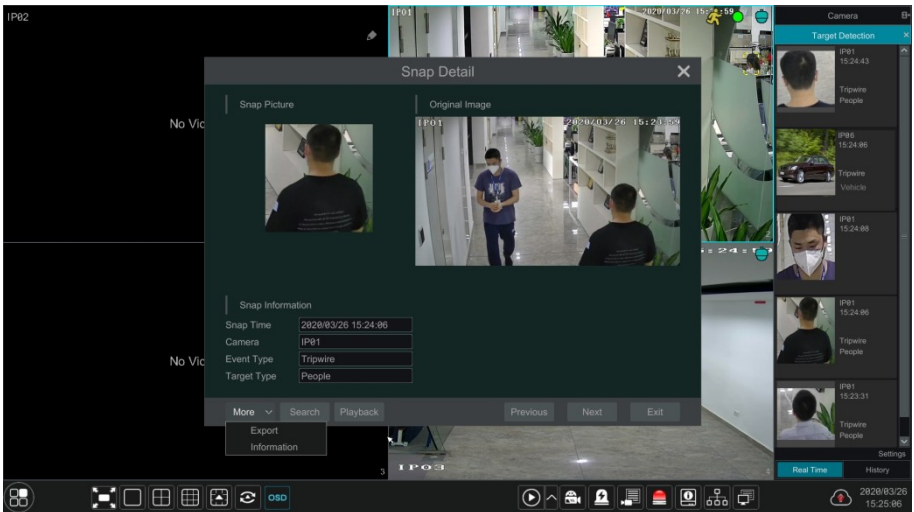



Click “More” to bring up a dropdown list. You can export the captured pictures by clicking “Export” or view the target ID by clicking “Information”. Click “Search” to go to smart human body/vehicle search interface. The system will automatically search captured people/vehicles. Click “Playback” to go to the playback interface.

10.1.2 Face Detection/Match View





Only the face recognition NVR supports the following functions. If your NVR doesn't support

them, please skip the following instructions.

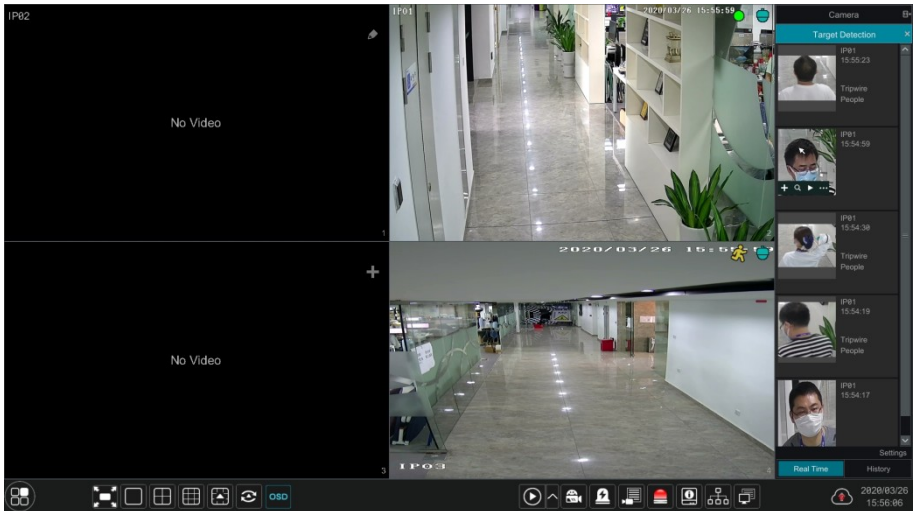
The setting steps are as follow:

- ① Enable face detection function (see [9.1.1 Face Detection Settings](#) for details).
- ② Enable face recognition function and set the alarm linkage items (see [9.1.3 Face Recognition Settings](#) for details).
- ③ Go to live view interface and click on a face detection channel. This will bring a toolbar under the channel. Then click  to go to the target detection interface of this channel. In this interface, you can switch the channel on the top right. You can also click  on the top right corner of the live view interface and then choose the target detection tab to go to the target detection interface of multi-channel as shown below.



For unknown faces, you can select this face and click  under the captured face to register this face (see the following picture); click  to quickly go to the smart face search interface where you can search the matching face information; click  to quickly go to the smart face playback interface; click  to view snapshot details.

Register

Snap Picture



Name

Sex

Birthday 

Native Place

ID Type

ID Number

Mobile No.

Remark

Group

Before registering target face pictures, please add groups for them in advance (see [9.1.2 Face Database Management](#) for details).

After the face pictures are registered, the system will compare them automatically once the corresponding faces are captured next time. Refer to the following picture.

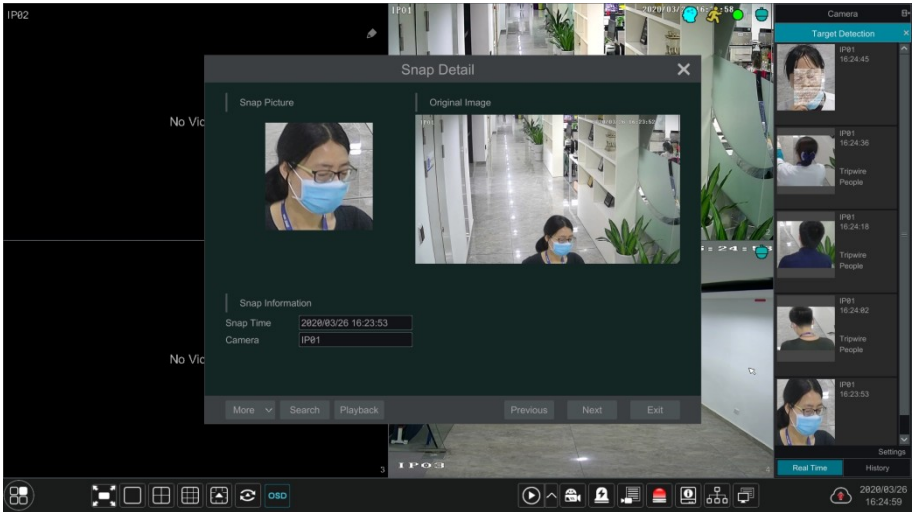

Double click the face picture to see the snapshot details, such as snapshot picture, original image, snapshot time and camera. Click “more” and then a dropdown list will display. Click “Register” to register the current snapshot. Click “Search” to go to face search interface. Click “Playback” to go to the playback interface. Click “Export” to export this snapshot details. Click “Information” to view face ID.

In the face match interface, click “Settings” to pop up the following window.

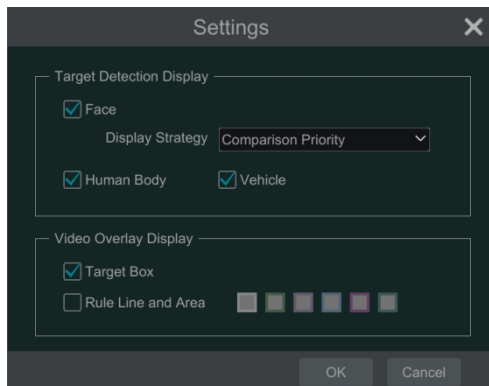

Target Detection Display: Face, human body and vehicle can be enabled. If disabled, the captured target picture will not be displayed under the target detection tab in the live view interface.

Display Strategy: Two options-Comparison priority and only comparison

Video Overlay Display:

If “Target box” is clicked, you will see the target traced by a little red box.

If “Rule Line and Area” is checked, you will see the rule line of line crossing detection and detection area of intrusion detection displayed on the screen. You can select the color of the rule line and area as needed.

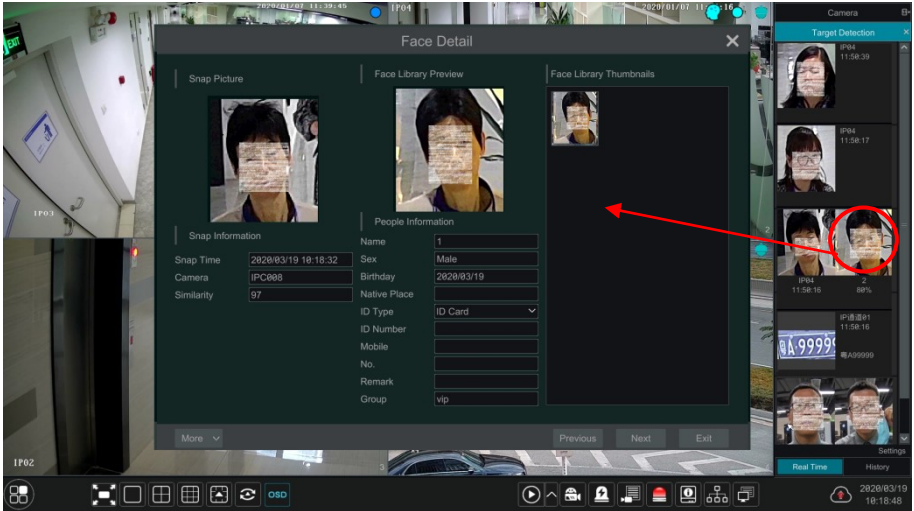

When the captured face pictures are successfully recognized, click the picture on the right to pop up a face detail window as shown below. In this window, you can see the captured face picture, the matched picture of face library and the relevant information. You also can view the original image, search image by snapshot, play back by snapshot and export the face details by clicking “More” button.

Additionally, you can view the historical captured face pictures and face match information in the face match interface by clicking “History” tab. Besides registering face pictures in the live view interface, you can also add target face pictures in the face database interface.

Note: if you enter the remark when adding a face picture to the face database, instead of the name, the remark information will be shown under the face library picture after successful recognition.

10.1.3 License Plate Detection/Recognition View

Only when the ANPR camera is added and enabled, can license plates be captured and matched. The setting steps are as follows

- ① Enable the plate detection function (See [9.2.1 License Plate Detection Settings](#) for details). Then you can see the captured plates displayed in the live view interface as shown below.

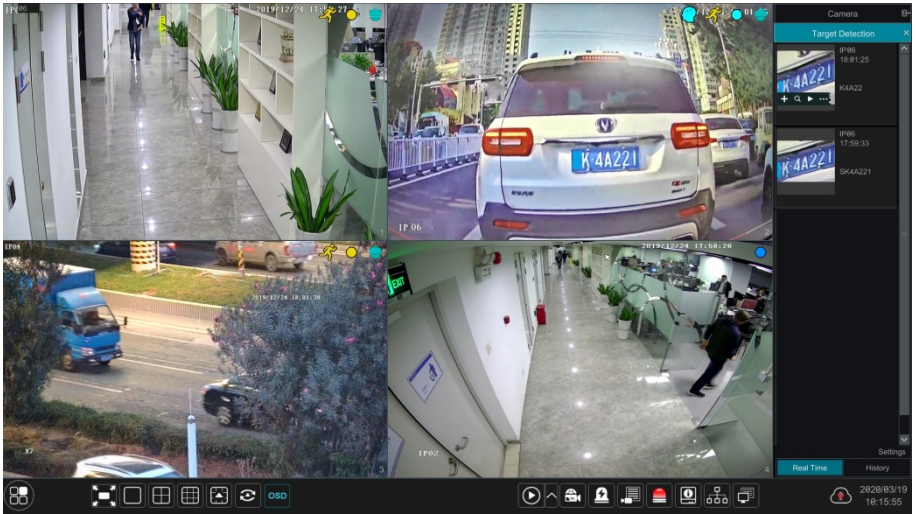

Put the cursor on the captured plate picture and then click **+** to register this plate as shown below.

Click **...** to view the captured detail information. Click **🔍** to quickly enter the vehicle search interface. You can search the matched plate information in this interface. Click **▶** to go to the smart playback interface.

② Enable license plate recognition function and set the alarm linkage items (see [9.2.3 License Plate Recognition Settings](#) for details).

③ Go to live view interface and click **+** on the top right corner of the live view interface and then choose the target detection tab to go to the target detection interface of multi-channel as shown below. When the plate is captured, it will be displayed on the right panel. If this plate is successfully matched, it will show “successful” beside the plate picture. The strange plate will show “Strange plate” beside the plate picture.

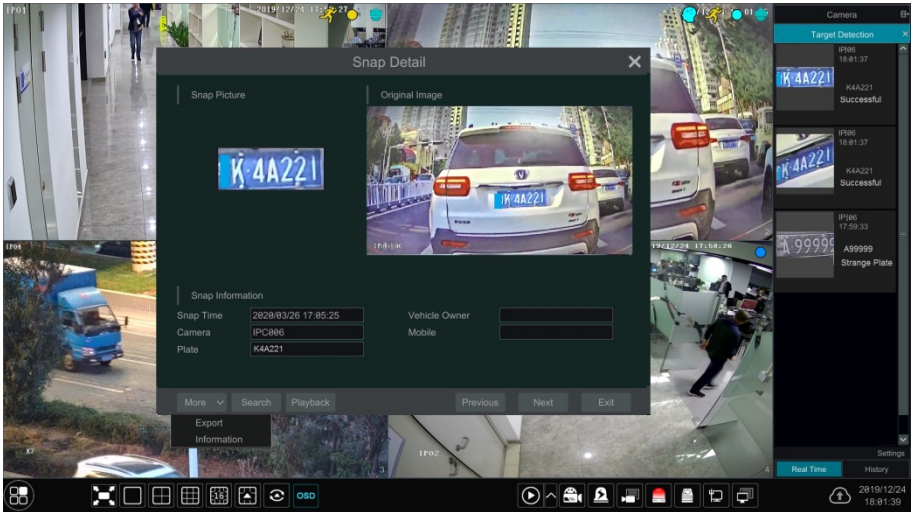

Click the captured plate picture and then it will pop up the detailed information window. You can view the snapshot picture, original picture, snapshot time, camera, etc. Click “More” to view the ID information of the target and export the captured picture. Click “Search” to go to the vehicle search interface. Click “Playback” to go to the playback interface.

10.2 Smart Search

10.2.1 Face Search

Only some models support this function. If your device doesn't support it, please skip the following instructions.

➤ Face Search by Event

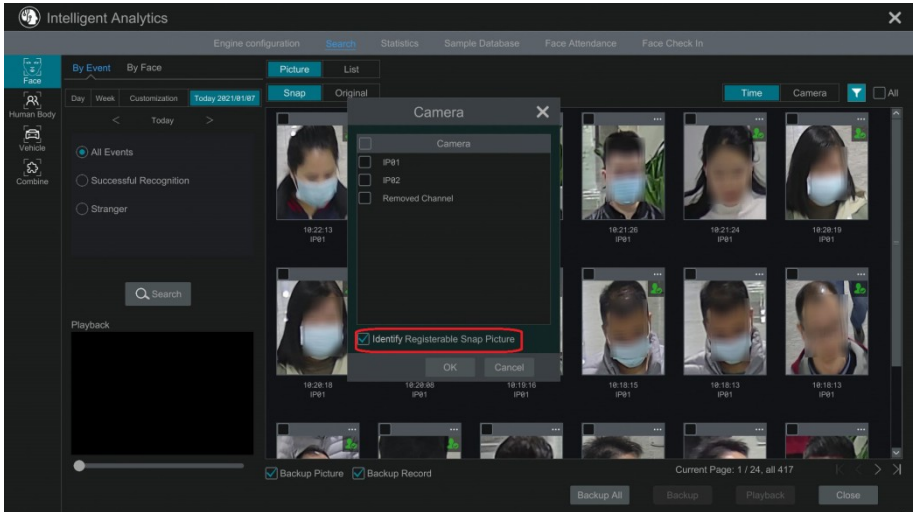

- ① Click Start → Intelligent Analytics → Search → Face to go to the following interface.

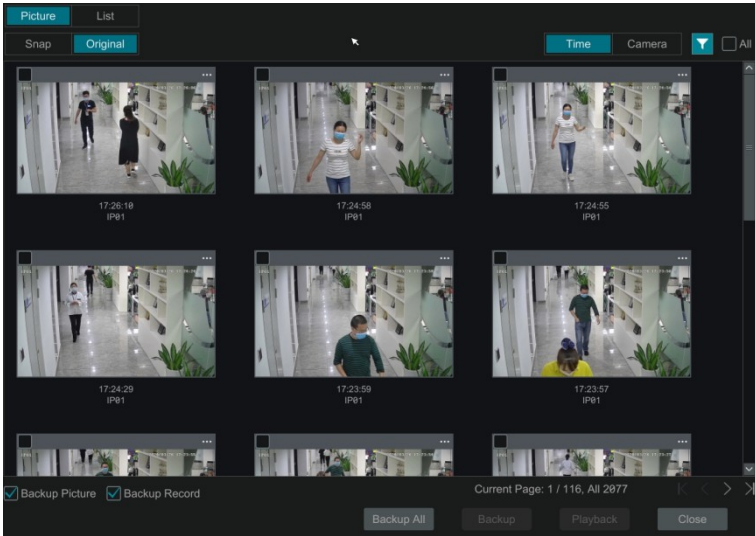

- ② Click  to choose face detection cameras. You can enable “Identify Registerable Snap Picture”. Then the picture which can be added to the face database will be marked with a green icon.
- ③ Select all events, successful recognition or stranger.
- ④ Click “Search” to search face pictures. You can view face pictures by time or by camera.
- ⑤ Click the searched face picture to play in the small playback window; select a face picture and click “Backup” to export it.

Click “Original” to see the original image as shown below.



Click “List” to view the snapshot information list. Click  to view the detail information; click  to back up the image.

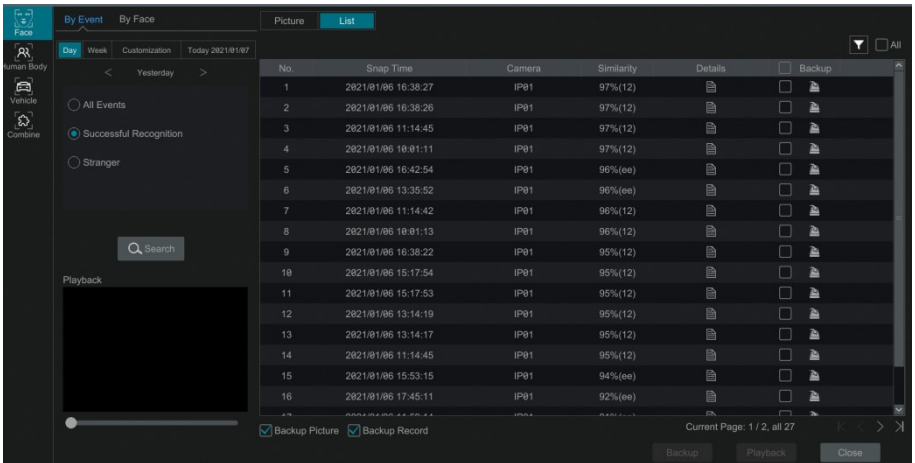

➤ Face Search by Face

In the face picture search interface, click “By Face” to go to the following interface.

① Click  to add the target face which can be searched and added from recent, face database, snapshot gallery and external faces. A single face picture or multiple face pictures can be added and searched. (Taking a single face picture for example)

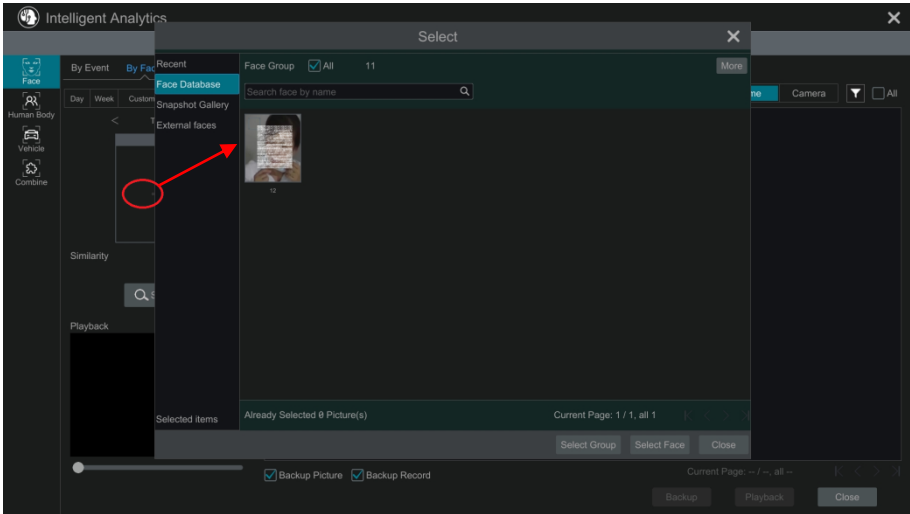

- To add target face from recent
- a. Choose the face.
 - b. Click “Select Face”.

To add target face from face database:

- a. Click “More” to choose groups.
- b. Select a target face and click “Select Face”.

To add target face from snapshot gallery:

- a. Select time and click “More” to choose cameras.
- b. Click “Search”.
- c. Check a face and click “Select Face”.

To add target face from external face:

- a. Save the target face to the mobile storage device and then insert this device into the USB interface of NVR.
 - b. Select “External Face” to import the face in this interface.
- ② Set similarity and then click “Search”.
 - ③ Click the searched image to play records in the small window.
 - ④ Select the searched image and click “Backup Picture” or “Backup Record”. Then click “Backup” to build backups for pictures or records.

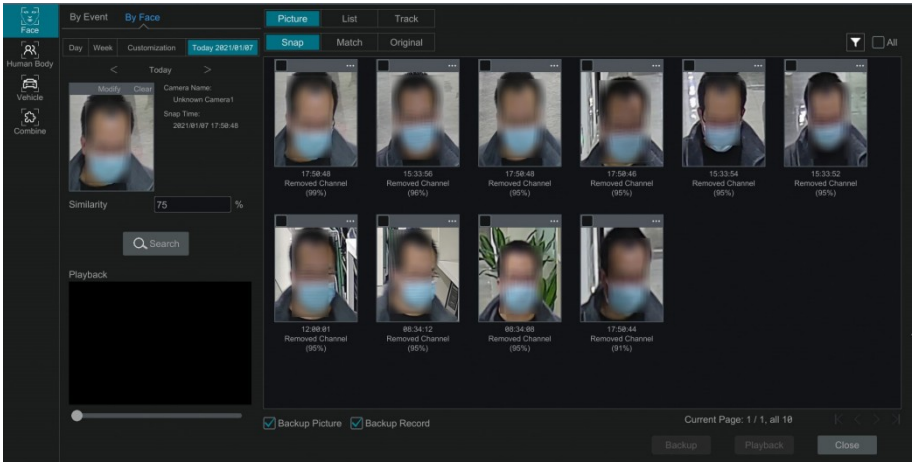

- **View Image by List**

Click “List” tab to view images by time as shown below.

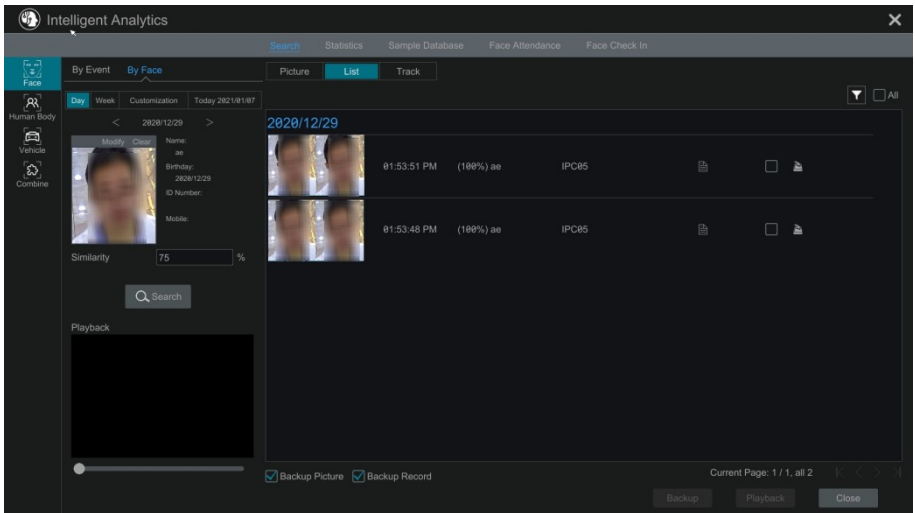

Click the searched image to play. Click  to view the detail information of the compared target face.

- **View Match Images**

Click “Match” tab to view match images as shown below.

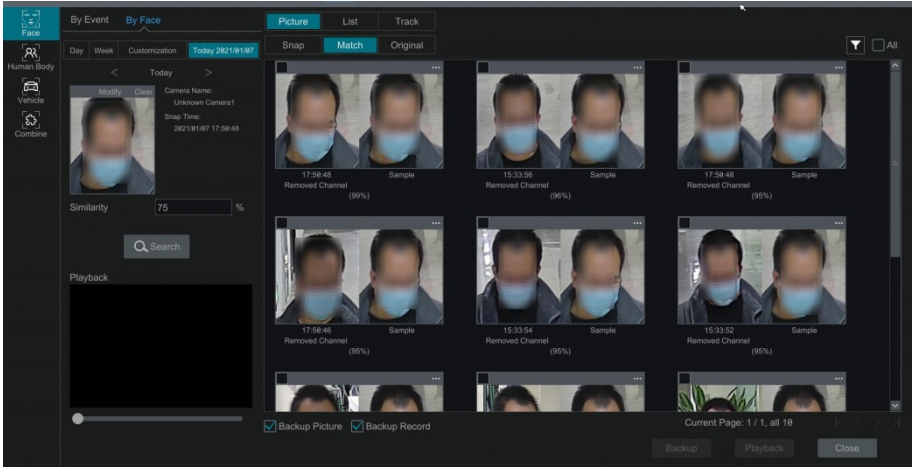

10.2.2 Track Playback



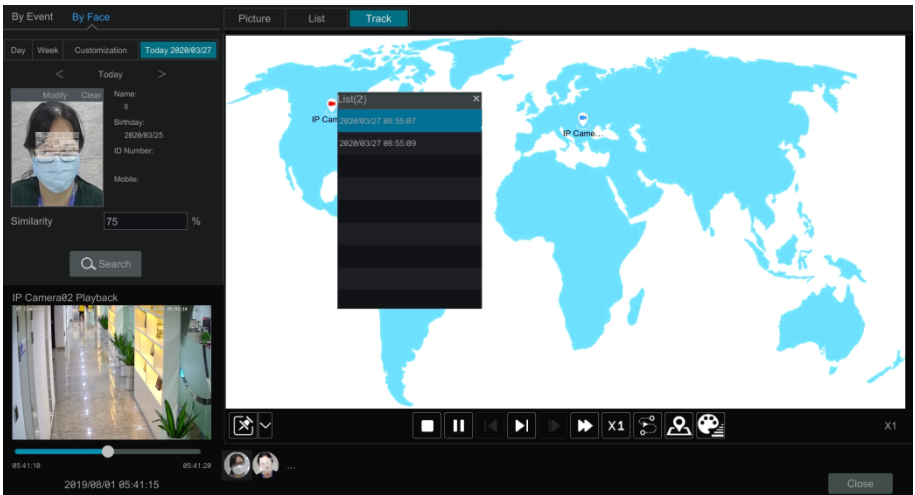



Select “Track” to go to the following interface.



Note: Only when two or more cameras detect this person, can his/her track can be viewed here.

Descriptions of buttons on the track interface



	Fixed Window		Frame
	Followed Window		Fast Forward (x2;x4)
	Exchange Window		Normal Speed

	Stop		Start/Stop Track
	Play		Edit Map
	Previous		Edit Color
	Next		

Click on the camera name and then an event list appears. Click one item to play the record.

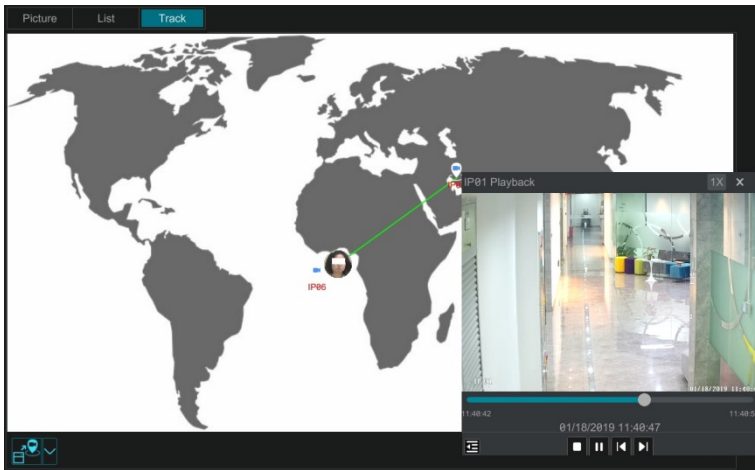
Click  button beside the fixed window icon to show “Followed Window” and “Exchange Window” icons. The small playback window will float on the map window by clicking “Followed Window” as shown below.



Click  to switch play speed. 1x and 2x can be switched. Click  to view event list. Click one item to play this event.

Click “Exchange Window” to switch the position of the map window and the playback window.

Click  button to go to the following interface.

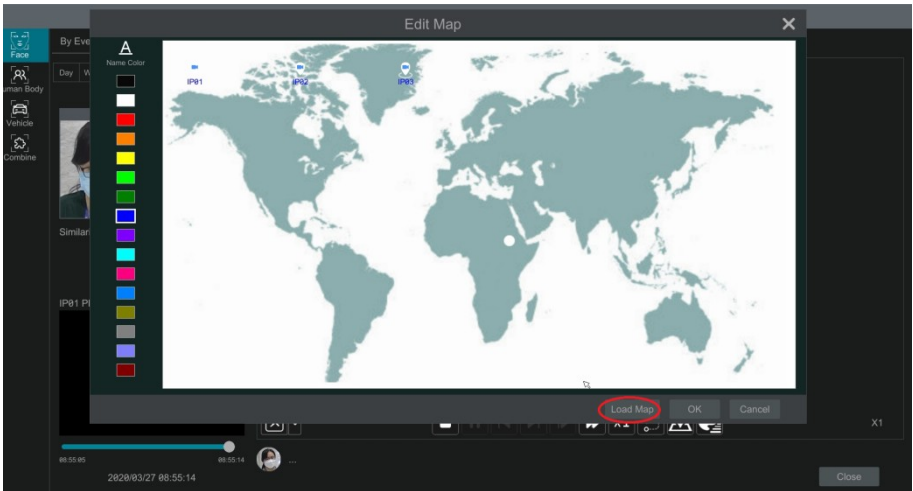

Click “Load Map” to add a map. Then drag the camera names on the map to change their locations. Choose a color on the left color list to set your favorite color for camera names.

Load Map: ① Save the map to the USB storage device and then insert the USB storage device into the NVR. ② Click “Load Map” button to upload the map.

Click  button to modify the colors of camera name and track line and set the line width.

10.2.3 Face Search by Snapshot

In the live or playback interface, click on a face detection camera and then select  on the toolbar. This will bring the following window.

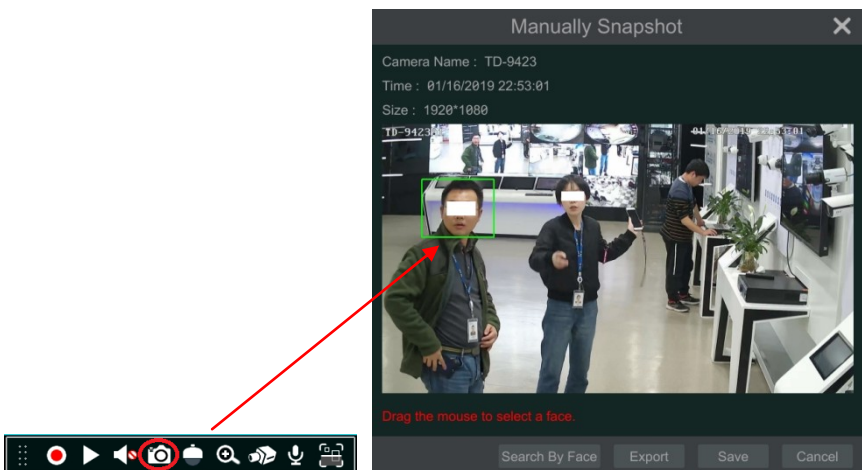

Drag the mouse to select a face and then click “Search by Face” to go to the face search by face

interface. You can see its snapshot pictures, match pictures, original pictures and so on by clicking the corresponding tab.



10.2.4 Human Body Search

Click Start→ Intelligent Analytics→Smart Search→Human Body to go to the human body search interface.

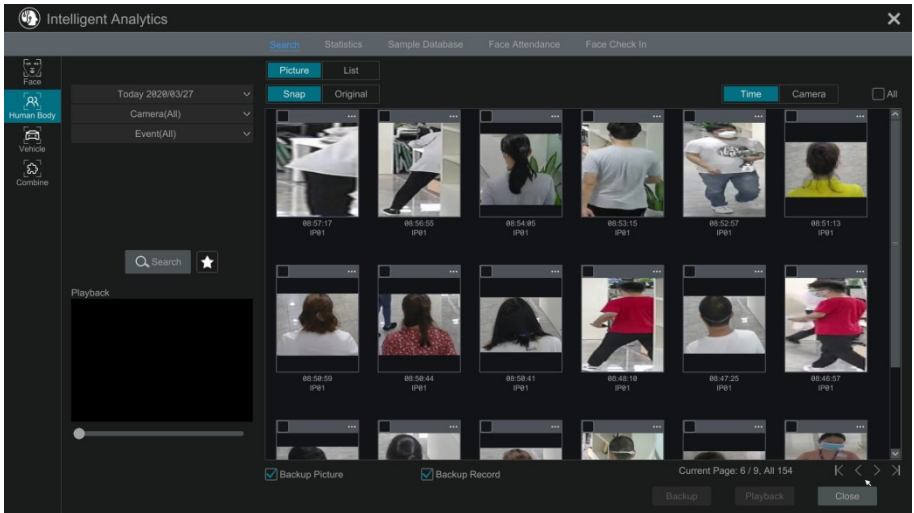
Select the search time, camera and event and then click “Search” to view the searched pictures.



Click the searched picture to play the record in the small window. Select pictures and check “Backup Picture” and/or “Backup Record” and then click “Backup” to back up the pictures and /or records. Click “Original” to view the captured original pictures. Click “List” to view the file list of the captured pictures.

Click  and select “Add to favorite” to add a favorite group and save the current searched pictures to the favorite group. Then you can quickly view these figure pictures by clicking  and choosing the group name.

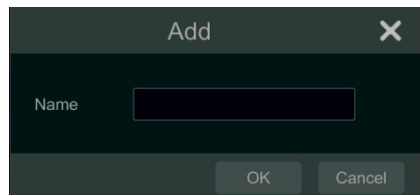
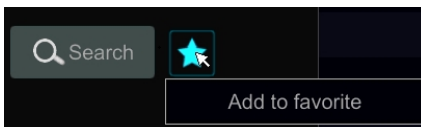



10.2.5 Vehicle Search

① Click Start→ Intelligent Analytics→Smart Search→Vehicle to go to the vehicle search interface.

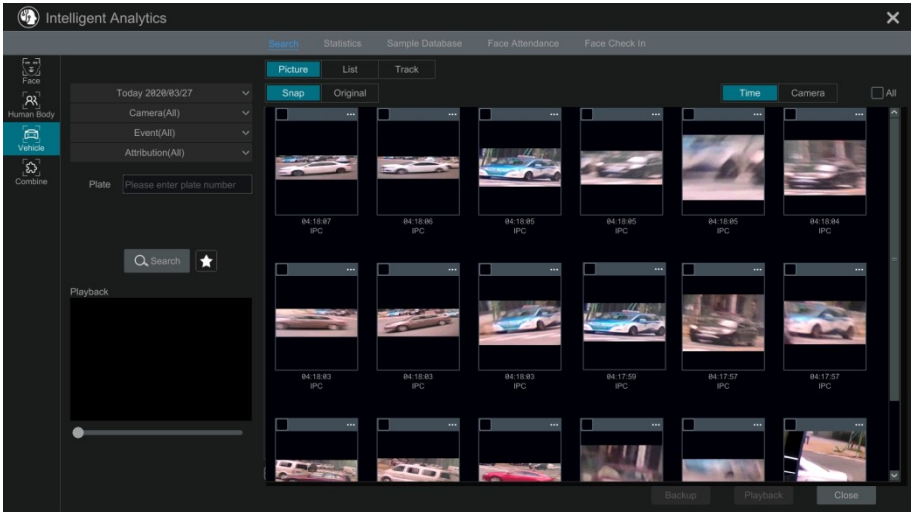
- ② Select the time, camera, event and vehicle type. Then click “Search” to search vehicles.
 Event: Intrusion, Line Crossing, Target Counting, Plate Detection, Plate Match-Successful Recognition and Plate Match-Strange Plate can be selected.
 Attribution: Vehicle or non-vehicle can be selected.
 You can view face pictures by time or by camera.



Click a searched vehicle picture to play it in the small window. Select vehicle pictures and check “Backup Picture” and/or “Backup Record” and then click “Backup” to back up the pictures and /or records.

- ③ Click “Original” to see the original pictures; click “List” to view the snapshot information list. Click  to view the detail information; click  to back up the image.

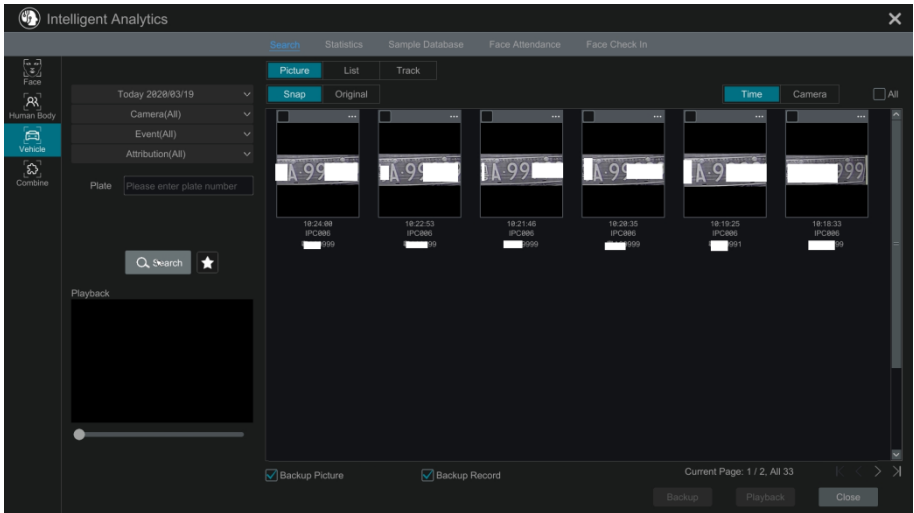

Select “Plate Detection” or “Plate Match” to view plate image. You can also enter the plate number to search the plate pictures. Then you can view the track of this vehicle.



Click “Track” to view the track of the vehicle.

Note: Only one plate can be traced at a time and there must be two or more ANPR cameras detect this vehicle, thus, you can view the track of this vehicle.

The track setting steps are similar to the face track settings. Please refer to face track settings for details.



Click  to add a favorite group and save the current searched pictures to the favorite group. Then you can quickly view these vehicle pictures by clicking  and choosing the group name.

10.2.6 Combination Search

If you want to view the human body, vehicle or face pictures simultaneously, you can choose combination search.

- ① Click “Combine”.
- ② Select the search time, camera, event and vehicle as needed.

Click a searched picture to play it in the small window. Select pictures and check “Backup Picture” and/or “Backup Record” and then click “Backup” to back up the pictures and /or records.

Click  to add a favorite group and save the current searched pictures to the favorite group. Then you can quickly view these pictures by clicking  and choosing the group name.

10.3 View Statistical Information

Click Start→ Intelligent Analytics→Statistics to go to the following interface. In this interface, you can view the people and vehicle statistical information or you can customize the statistical

information.

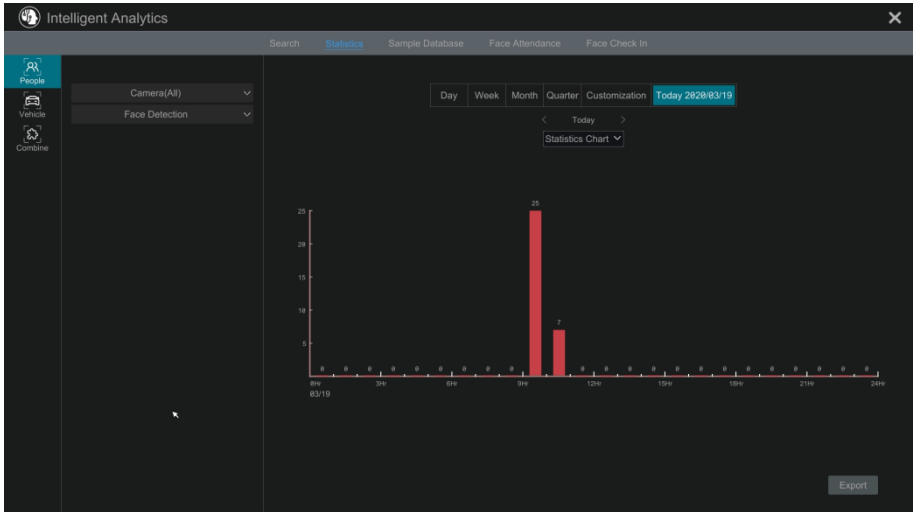

View People Information:

Note: The person information includes face information and figure information.

- ① Select the time.
- ② Select cameras.
- ③ Select events as needed, such as face detection, face recognition, intrusion, line crossing, target counting, etc.

Note: Face recognition events (successful recognition & stranger) are available for some models. If Face Recognition-Successful Recognition event is selected, you can choose “Detail Chart” to view.

View Vehicle Information:

- Click “Vehicle”
- Select the time and cameras.
- Select events as needed.
- Select the vehicle attribution.

To customize statistical information:

Click “Combine” and then select events, people and vehicle as needed.

10.4 Face Attendance

This function is only available for some models. If your device doesn’t support it, please skip the following instructions.

Click Start→Intelligent Analytics→Face Attendance to go to the following interface.

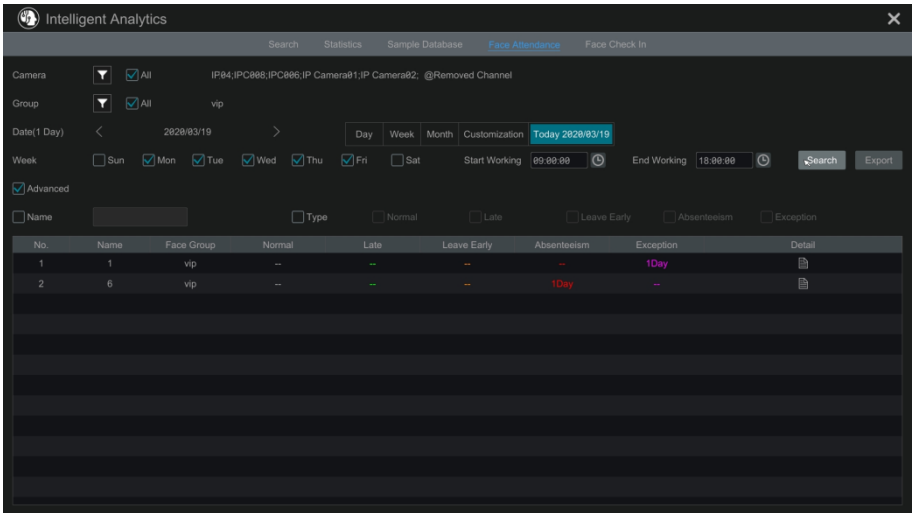

To search attendance information

- ① Click behind camera and group to choose the desired cameras and groups.
- ② Set the attendance date. You can choose day, week, month and today or customize the time period.
- ③ Set the start time and the end time of working.
- ④ Click “Search” to view the attendance state.

If some specific person’s attendance state needs to know, you can click “Advanced” and then enter the name and choose the type.

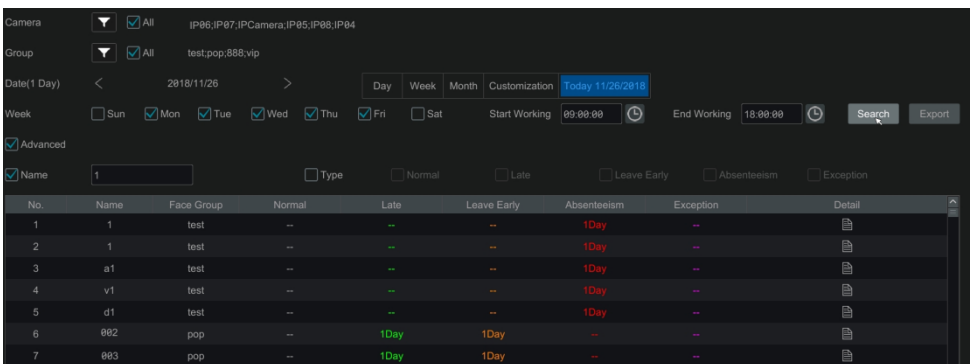

Click “Export” to export the searched attendance information.

Click to view the detailed information of attendance. In this interface, click to go to the face search interface.

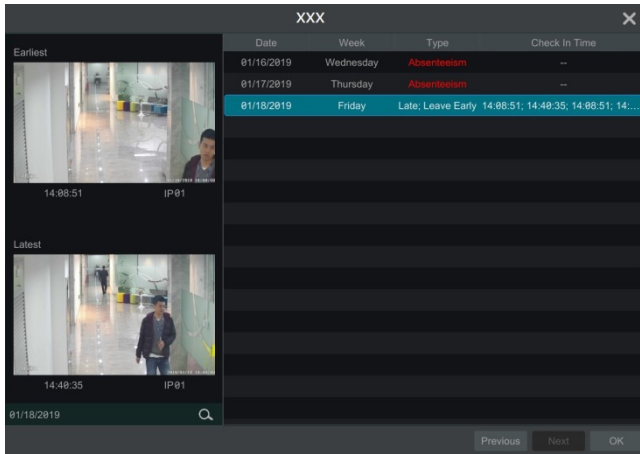

10.5 Face Check-In

Click Start→Intelligent Analytics→Face Attendance to go to the following interface.

The search steps of face check-in are as follows.

- ① Click  behind camera and group to choose the desired cameras and groups.
- ② Set the check-in date. You can choose day, week, month and today or customize the time period.
- ③ Set the start time and the end time of face check-in.
- ④ Click “Search” to view the check-in state.

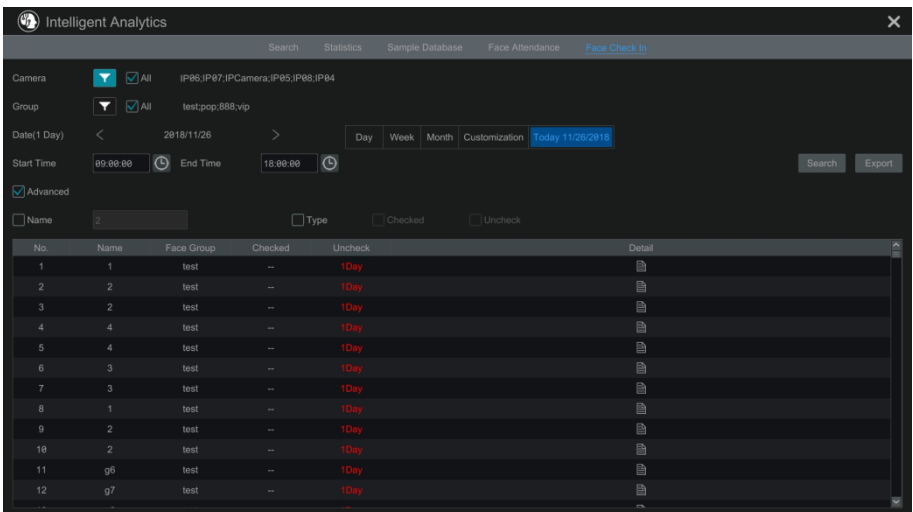

If you want to know the detailed check-in information of someone, please click “Advanced” and then enter the name and choose the type to search.

Click  to view the detailed information. In this interface, the checked image can be viewed.

Click  to view the registered face picture of this person.

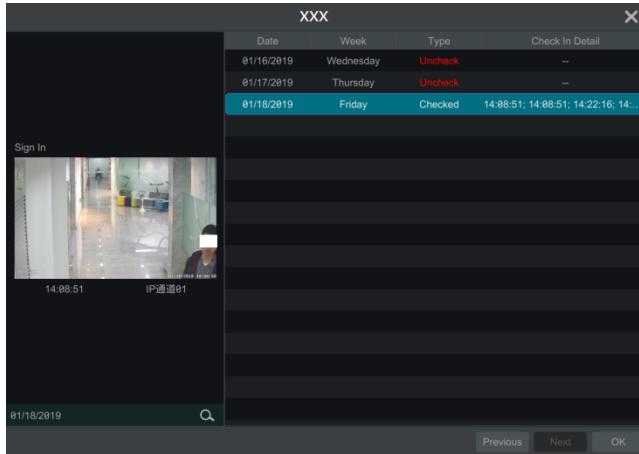

The screenshot shows a window titled 'XXX' with a close button. On the left, there is a 'Sign In' video feed showing a person's face. Below the video, the time '14:08:51' and the IP address 'IP通道01' are displayed. At the bottom left of the video area, the date '01/18/2019' and a magnifying glass icon are visible. On the right, there is a table with the following data:

Date	Week	Type	Check In Detail
01/16/2019	Wednesday	Uncheck	--
01/17/2019	Thursday	Uncheck	--
01/18/2019	Friday	Checked	14:08:51; 14:08:51; 14:22:16; 14:...

At the bottom right of the window, there are buttons for 'Previous', 'Next', and 'OK'.

10.6 Enabling AI Mode

Only some models support this function.

For these models, the IP camera without AI function added to the NVR may realize AI functions, like face detection, line crossing and intrusion by enabling AI mode in the NVR. If AI mode is enabled, the secondary output will be disabled. Click Start→Intelligent Analytics→Engine Configuration.

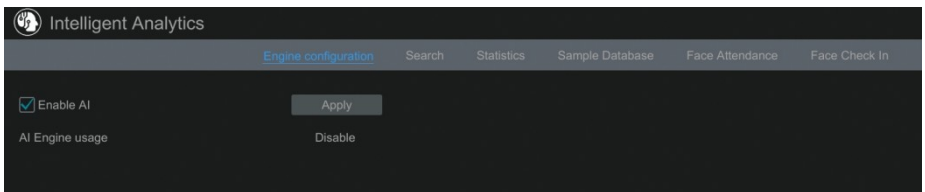

The screenshot shows the 'Intelligent Analytics' interface with a navigation bar at the top containing 'Engine configuration', 'Search', 'Statistics', 'Sample Database', 'Face Attendance', and 'Face Check In'. The 'Engine configuration' section is active, showing a checkbox for 'Enable AI' which is checked. Below it, there is a label 'AI Engine usage' and a 'Disable' button. An 'Apply' button is also present.

11 General Event Management

11.1 Sensor Alarm

To complete the entire sensor alarm settings, you should enable the sensor alarm of each camera and then set up the alarm handling of each camera.



- Click Start→Settings→Alarm→Sensor to go to the following interface.

No.	Alarm Name	Schedule	Type	Enable	Duration	Record	Snapshot	Push	Alarm-out
Local-1	Sensor1	24x7	NO	ON	30 Secs	<input type="checkbox"/> Configure	<input type="checkbox"/> Configure	ON	<input type="checkbox"/> Configure
Local-2	Sensor2	24x7	NO	ON	30 Secs	<input type="checkbox"/> Configure	<input type="checkbox"/> Configure	ON	<input type="checkbox"/> Configure
Local-3	Sensor3	24x7	NO	ON	30 Secs	<input type="checkbox"/> Configure	<input type="checkbox"/> Configure	ON	<input type="checkbox"/> Configure
Local-4	Sensor4	24x7	NO	ON	30 Secs	<input type="checkbox"/> Configure	<input type="checkbox"/> Configure	ON	<input type="checkbox"/> Configure
Local-5	Sensor5	24x7	NO	ON	30 Secs	<input type="checkbox"/> Configure	<input type="checkbox"/> Configure	ON	<input type="checkbox"/> Configure
Local-6	Sensor6	24x7	NO	ON	30 Secs	<input type="checkbox"/> Configure	<input type="checkbox"/> Configure	ON	<input type="checkbox"/> Configure
Local-7	Sensor7	24x7	NO	ON	30 Secs	<input type="checkbox"/> Configure	<input type="checkbox"/> Configure	ON	<input type="checkbox"/> Configure
Local-8	Sensor8	24x7	NO	ON	30 Secs	<input type="checkbox"/> Configure	<input type="checkbox"/> Configure	ON	<input type="checkbox"/> Configure

- Select the alarm type (NO or NC) according to trigger type of the sensor.
- Enable the sensor alarm of each camera and select the schedule.
- Check the “Duration”, “Record”, “Snapshot”, “Push”, “Alarm-out” and “Preset” and enable or disable the “Buzzer”, “Pop-up Video”, “Pop-up Message Box” and “E-mail” as required.
- Click “Apply” to save the settings.

The configuration steps of the above mentioned alarm linkages are as follows.

Duration: it refers to the interval time between the adjacent motion detections. For instance, if the duration time is set to 10 seconds, once the system detects a motion, it will go to alarm and would not detect any other motion (specific to camera) in 10 seconds. If there is another motion detected during this period, it will be considered as continuous movement; otherwise it will be considered as a single motion.

Record: check it and then the “Trigger Record” window will pop up automatically (you can also click the “Configure” button to pop up the window). Select camera on the left side and then click  to set the camera as the trigger camera. Select trigger camera on the right side and then click  to cancel the trigger camera. Click “OK” to save the settings. The trigger cameras will record automatically when the sensor alarm is triggered.

Snapshot: check it and then the “Trigger Snapshot” window will pop up automatically. Configure the trigger camera in the window. The trigger cameras will capture images automatically when the sensor alarm is triggered.

Push: check it and choose ON or OFF. If it is ON, the system will send messages when the sensor alarm is triggered.

Alarm-out: check it and then the “Trigger Alarm-out” window will pop up automatically.

Configure the trigger alarm-out in the window. The system will trigger the alarm-out automatically when the sensor alarm is triggered. You need to set the delay time and the schedule of the alarm outputs. See [11.5.1 Alarm-out](#) for details.

Preset: check it and then the “Trigger Preset” window will pop up automatically. Configure the trigger preset of each camera. To add presets, please see [6.2 Preset Setting](#) for details.

Buzzer: if enabled, the system will begin to buzz when the sensor alarm is triggered. To set the delay time of the buzzer, please see [11.5.4 Buzzer](#) for details.

Pop-up Video: After camera setting, the system will pop up the corresponding video automatically when the sensor alarm is triggered. To set the duration time of the video, please see [11.5.3 Display](#) for details.

Pop-up Message Box: if enabled, the system will pop up the corresponding alarm message box automatically when the sensor alarm is triggered. To set the duration time of the message box, please see [11.5.3 Display](#) for details.

E-mail: if enabled, the system will send an e-mail when the sensor alarm is triggered. Before you enable the email, please configure the recipient’s e-mail address first (see [13.1.5 E-mail Configuration](#) for details).

Virtual alarm: This function should be used with API server. If you want to enable it, please make sure the API Server is enabled first (Start→Network→Port) and then set the authentication as “Digest”.

11.2 Motion Alarm

Motion Alarm: when the motion object appears in the specified area, it will trigger the alarm. You should enable the motion of each camera first and then set the alarm handling of the camera to complete the whole configuration of the motion alarm.

11.2.1 Motion Configuration

- ① Click Start→Settings→Camera→Motion Settings to go to the following interface.



- ② Select the camera, enable the motion and set the sensitivity and duration of the camera.

Sensitivity: the higher the value is, the more sensitive it is to motion. You should adjust the value according to the practical conditions since the sensitivity is influenced by color and time (day or night).

Duration: it refers to the interval time between the adjacent motion detections. For instance, if the duration time is set to 10 seconds, once the system detects a motion, it will go to alarm, and would not detect any other motion (specific to camera) in 10 seconds. If there is another motion detected during this period, it will be considered as continuous movement; otherwise it will be considered as a single motion.
- ③ Drag the camera image to set the motion area. You can set more than one motion area. Click “All” to set the whole camera image as the motion area. Click “Reverse” to swap the motion area and the non-motion area. Click “Clear” to clear all the motion areas.
- ④ Click “Apply” to save the settings. Click “Processing Mode” to go to the alarm handling configuration interface of the motion alarm.

11.2.2 Motion Alarm Handling Configuration

- ① Click Start→Settings→Alarm→Motion Alarm to go to the following interface.

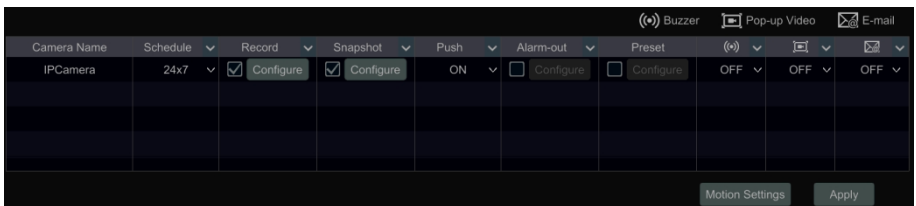

- ② Enable or disable “Record”, “Snapshot”, “Push”, “Alarm-out”, “Preset”, “Buzzer”, “Pop-up Video” and “E-mail”. The alarm handling setting of motion alarm is similar to that of the sensor alarm (see [11.1 Sensor Alarm](#) for details).
- ③ Click “Apply” to save the settings. You can click “Motion Settings” to go to the motion configuration interface.

11.3 Combination Alarm

- ① Click Start→Settings→Alarm →Combination Alarm to go to the following interface.
- ② Customize combination alarm. Set alarm name and click “Configure” under the Combined Alarm Configuration item(motion/sensor/intrusion/face recognition/line crossing). Then select alarm type and alarm source. Finally, click “OK” to save the settings.
- ③ Enable or disable “Record”, “Snapshot”, “Push”, “Alarm-out”, “Preset”, “Buzzer”, “Pop-up Video” and “E-mail”. The alarm handling setting of combination alarm is similar to that of the sensor alarm (see [11.1 Sensor Alarm](#) for details).
- ④ Click “Apply” to save the settings.

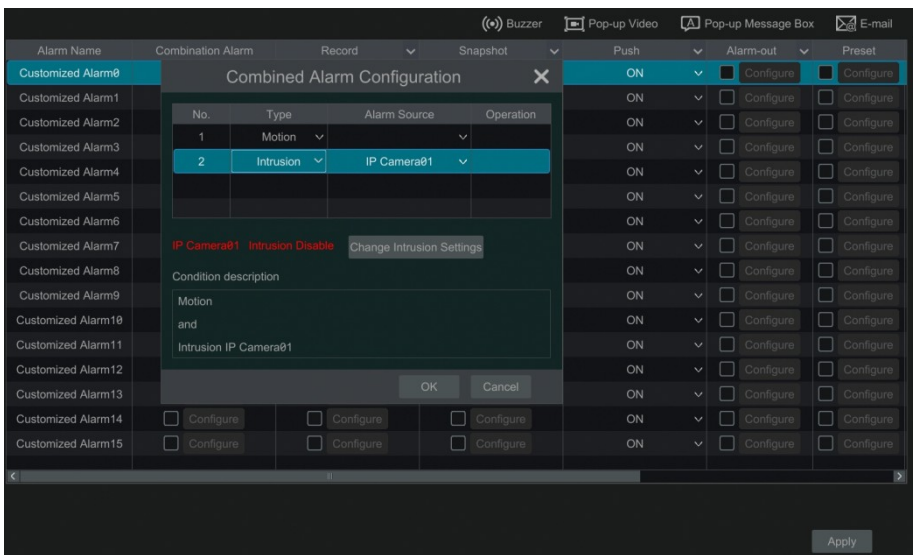

11.4 Exception Alarm

11.4.1 IPC Offline Settings

- ① Click Start→Settings→AI/Event→IPC Offline Settings to go to the interface as shown below.
- ② Enable or disable “Snapshot”, “Push”, “Alarm-out”, “Preset”, “Buzzer”, “Pop-up Video”, “Pop-up Message Box” and “E-mail”. The IPC Offline Settings are similar to that of the sensor alarm (see [11.1 Sensor Alarm](#) for details).
- ③ Click “Apply” to save the settings.

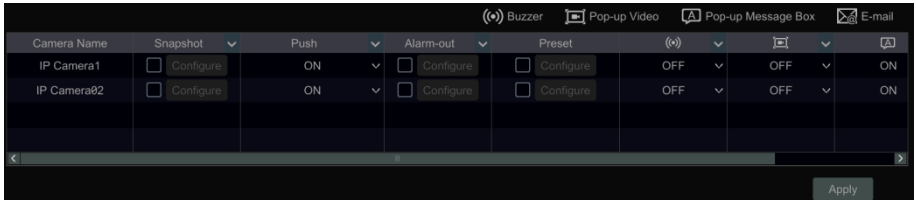

11.4.2 Exception Alarm Settings

- Click Start→Settings→AI/Event→Exception Alarm to go to the interface as shown below.

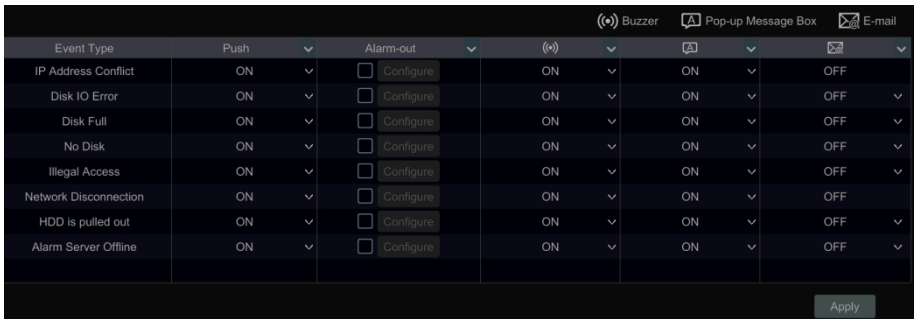

- Enable or disable “Push”, “Alarm-out”, “Buzzer”, “Pop-up Message Box” and “E-mail”. The exception handling settings are similar to that of the sensor alarm (see [11.1 Sensor Alarm](#) for details).
- Click “Apply” to save the settings.

11.5 Alarm Event Notification

11.5.1 Alarm-out

- Click Start→Settings→AI/Event→Event Notification to go to the following interface.

No.	Name	Delay	Schedule	Type	Test
Local-1	AlarmOut1	10 Secs	24x7	NO	Test
Local-2	AlarmOut2	10 Secs	24x7	NO	Test
Local-3	AlarmOut3	10 Secs	24x7	NO	Test
Local-4	AlarmOut4	10 Secs	24x7	NO	Test

- Set the delay time the schedule and type of each alarm-out. You can click “Edit Schedules” to edit the schedules (see [7.1.2 Schedule Settings](#) for details).
- Click “Apply” to save the settings. You can click “Test” to test the alarm output.

11.5.2 E-mail

Click Start→Settings→AI/Event→Event Notification→E-mail to go to the e-mail

configuration interface. Set the e-mail address of the recipients. See [13.1.5 E-mail Configuration](#) for details.

11.5.3 Display

Click Start→Settings→AI/Event→Event Notification→Display to go to the display configuration interface. Set the duration time of the pop-up video and the pop-up message box. If you device support two outputs, please set the output of the pop-up video as needed. After that, click “Apply” to save the settings.

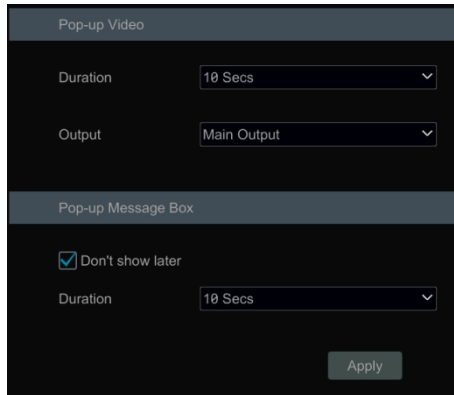

The screenshot shows the 'Display' configuration interface. It is divided into two sections: 'Pop-up Video' and 'Pop-up Message Box'. In the 'Pop-up Video' section, there are two dropdown menus: 'Duration' set to '10 Secs' and 'Output' set to 'Main Output'. The 'Pop-up Message Box' section has a checked checkbox for 'Don't show later' and a 'Duration' dropdown menu set to '10 Secs'. An 'Apply' button is located at the bottom right of the interface.

11.5.4 Buzzer

Click Start→Settings→AI/Event→Event Notification→Buzzer to go to the buzzer configuration interface. Set the delay time of the buzzer and then click “Apply” to save the setting. You can click “Test” to test the buzzer.

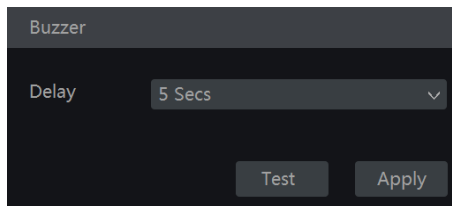

The screenshot shows the 'Buzzer' configuration interface. It features a 'Delay' dropdown menu set to '5 Secs'. At the bottom of the interface, there are two buttons: 'Test' and 'Apply'.

11.5.5 Push Message

Click Start→Settings→ AI/Event →Event Notification→Push Message to go to the interface as shown below. Check “Enable” and then click “Apply” to save the settings. If Push Server is online, it will push messages to the mobile clients.

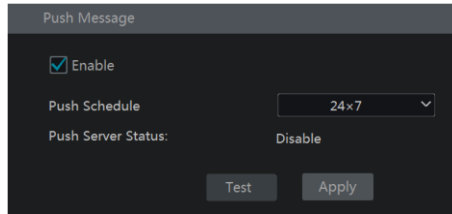

11.5.6 Audio

Click Start→Settings→ AI/Event →Event Notification→Audio to go to the interface as shown below.

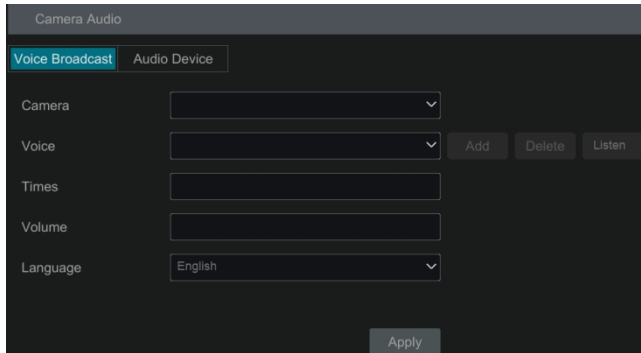

Camera audio settings:

For perimeter alert cameras, voice broadcast can be set up. Select the camera, voice, broadcast times, volume and language. Then click “Apply” to save the settings. When an alarm is triggered, camera will broadcast the voice you set.

Voice: click “Add” to add the alarm voice in wav. format. Click “Listen” to listen to the uploaded audio.

Click “Audio Device” to set the audio of the camera.

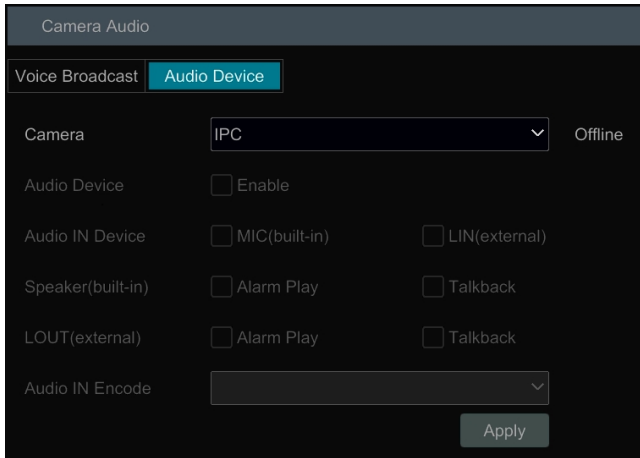

Select the camera and then enable audio device.

Audio IN Device: Please select it according to the actual device configuration.

Speaker (built-in): Please select its function as needed.

LOUT: external audio output device, please select its function as needed.

Audio Input Encode: G711A/G711U

Local Audio Alarm

Set the audio alarm of local NVR.

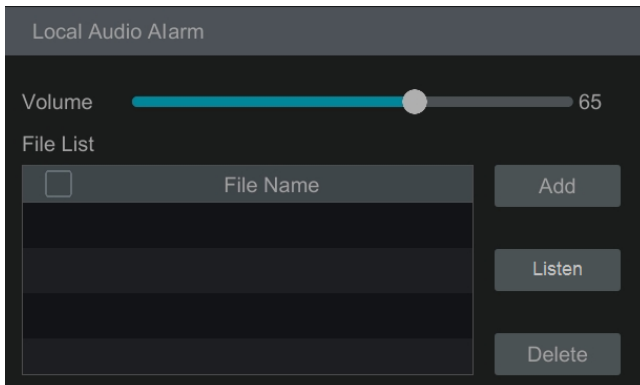

In this interface, you can set the volume of local audio. Click “Add” to upload the audio file. Choose the uploaded audio file and then click “Listen” to listen to it; click “Delete” to delete this file.

11.5.7 Light

Click Start→Settings→Alarm→Event Notification→Light to go to the interface as shown below. In this interface, you can set the light flashing time and frequency when an alarm is triggered.

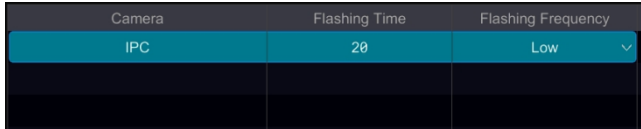

11.5.8 Alarm Server

Go to Alarm→Alarm Server interface as shown below.

Enable the alarm server and enter server address and port of the alarm server. Then select protocol. If “Send Heartbeat” is enabled, set the interval times. After that, test the effectiveness of the alarm server. Having tested successfully, please click “Apply”. When an alarm occurs, the device will transfer the alarm event to the alarm server. If an alarm server is not needed, there is no need to configure this section.

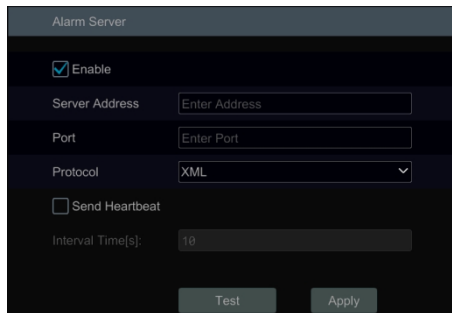

11.6 Manual Alarm

Click  on the tool bar at the bottom of the live preview interface to pop up a window. Click “Trigger” to start alarm. Click “Clear” to stop alarm.

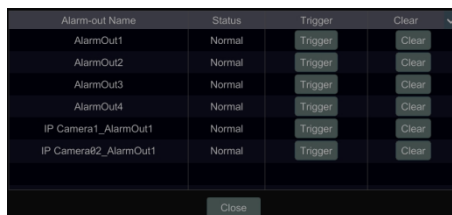



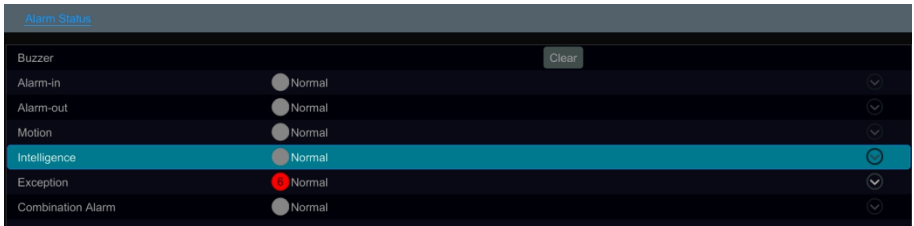

11.7 View Alarm Status

Click Start→Settings→Alarm→Alarm Status or click  on the tool bar at the bottom of the live preview interface to view the alarm status.

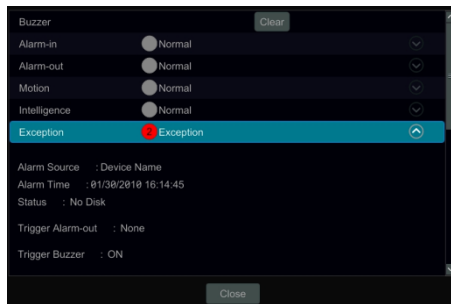

Click “Clear” to stop the buzzer when the buzzer alarm happens. Click  to view the detail information as shown below.



If the exception information is more than one page, you can enter the number in the box and then click  to jump to the specified page. Click  /  to view the exception alarm information in the previous/next page.

12 Account & Permission Management

12.1 Account Management

Click Start→Settings→Account and Authority→Account→Edit User to go to the interface as shown below.

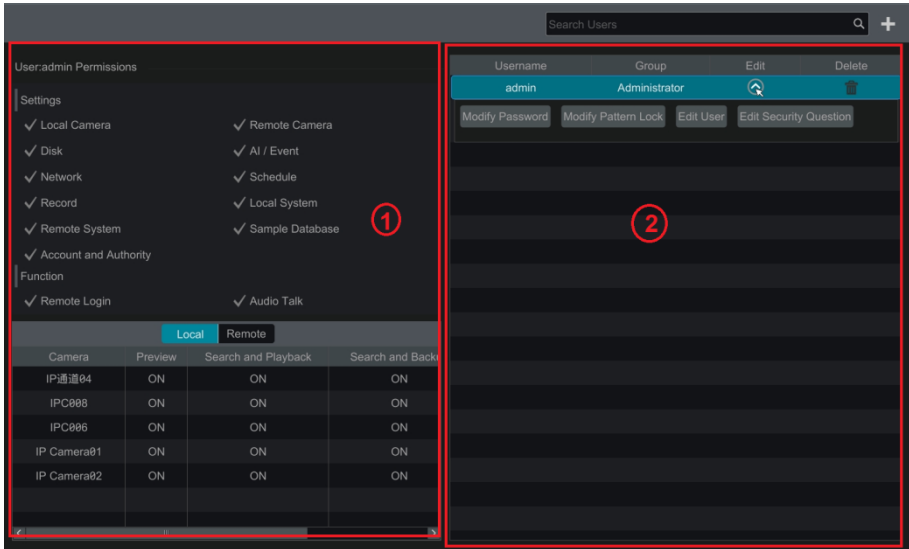

Area ① displays the user permissions. Area ② displays the user list. Click the user in the list to display its user permissions in area ①.

There are three default permission groups (“Administrator”, “Advanced” and “Common”) available when adding accounts. You can manually add new permission group (see [12.3.1 Add Permission Group](#) for details).



Only *admin* and the users that have the “Account and Authority” permission can manage the system’s accounts. Group “Administrator” owns all the permissions displayed in area ① except “Account and Authority” and its permissions cannot be changed while the permissions of “Advanced” and “Common” can be changed.

12.1.1 Add User

① Click Start→Settings→Account and Authority→Account→Add User or click  beside the search box to pop up the window as shown below.

② Set the username, password and group. User can also set the pattern lock here. The e-mail address and MAC address are optional (enter the MAC address after you check it). Click “Add” to add the user.

12.1.2 Edit User

Click Start→Settings→Account and Authority→Account→Edit User and then click  in the user list or double click the user to edit the user information. Click  to delete the user (the user *admin* cannot be deleted).

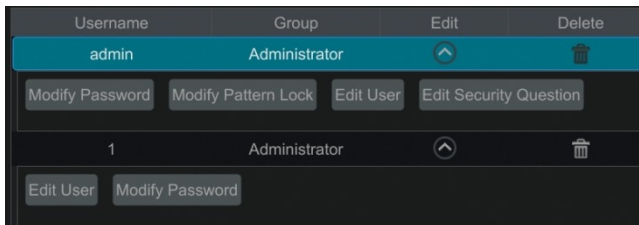

➤ Edit Security Question

You can set password security only for *admin*. Click “Edit Security Question” and then set questions and answers in the popup window. If you forget the password for *admin*, please refer to Q4 in [Appendix A FAQ](#) for details. The passwords of other users can be recovered by *admin* or the users that have the “Account and Authority” permission.

➤ Modify Password

The password of *admin* can be modified. Click “Modify Password” to pop up a window. Enter the current password and then set new password. Click “OK” to save the settings. In addition, the admin user can modify the common/advanced user’s password.

➤ Modify Pattern Lock

Some models may not support this function.

Click “Modify Pattern Lock” to pop up a window.

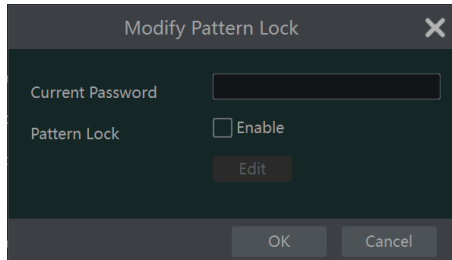

Input current password and then check “Enable” to set pattern lock.

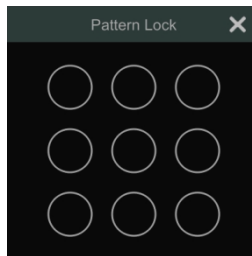

➤ Edit User

Click “Edit User” to pop up the window as shown below. The **admin** is enabled, its permission control is closed and permission group cannot be changed by default. You can enable or disable other users (if disabled, the user will be invalid), open or close their permission control (if closed, the user will get all the permissions which **admin** has) and set their permission groups. Click “OK” to save the settings.

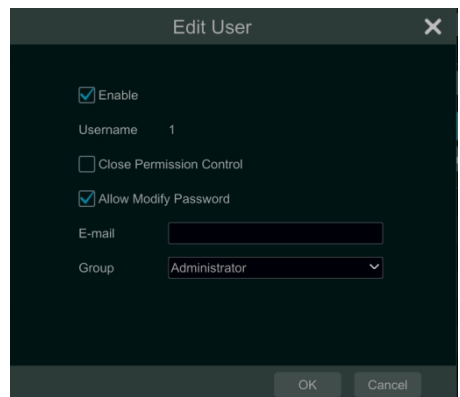
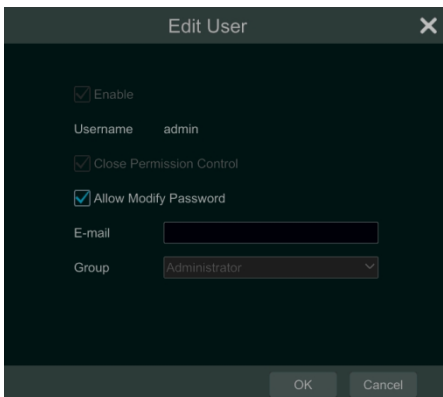

12.2 User Login & Logout

Login: Click Start→Login or directly click the preview interface and then select username and enter the password in the popup window. Click the “Login” button to log in the system.

Logout: Click Start→Logout or click Start→Shutdown to pop up the “Shutdown” window. Select “Logout” in the window and then click “OK” to log out the system.

12.3 Permission Management

12.3.1 Add Permission Group

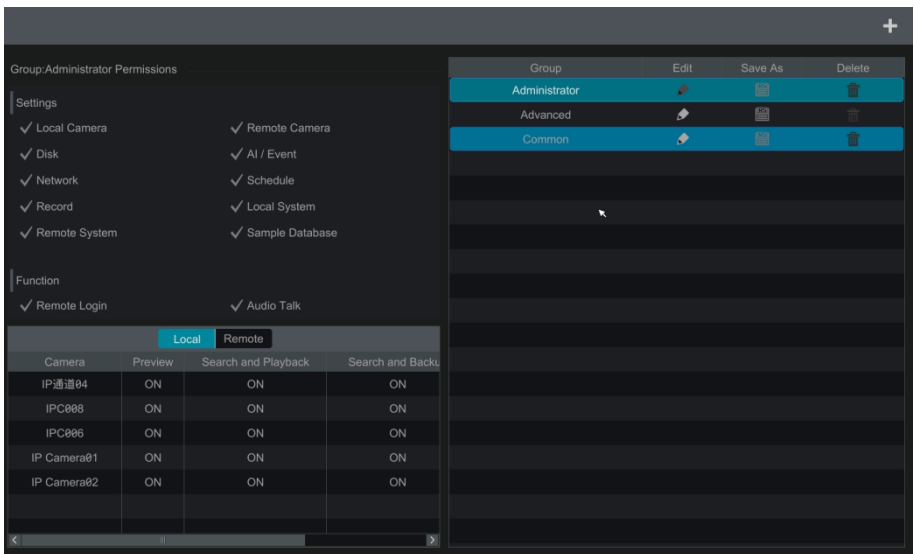

Click Start→Settings→Account and Authority→Account→Edit Permission Group to go to the interface as shown below.

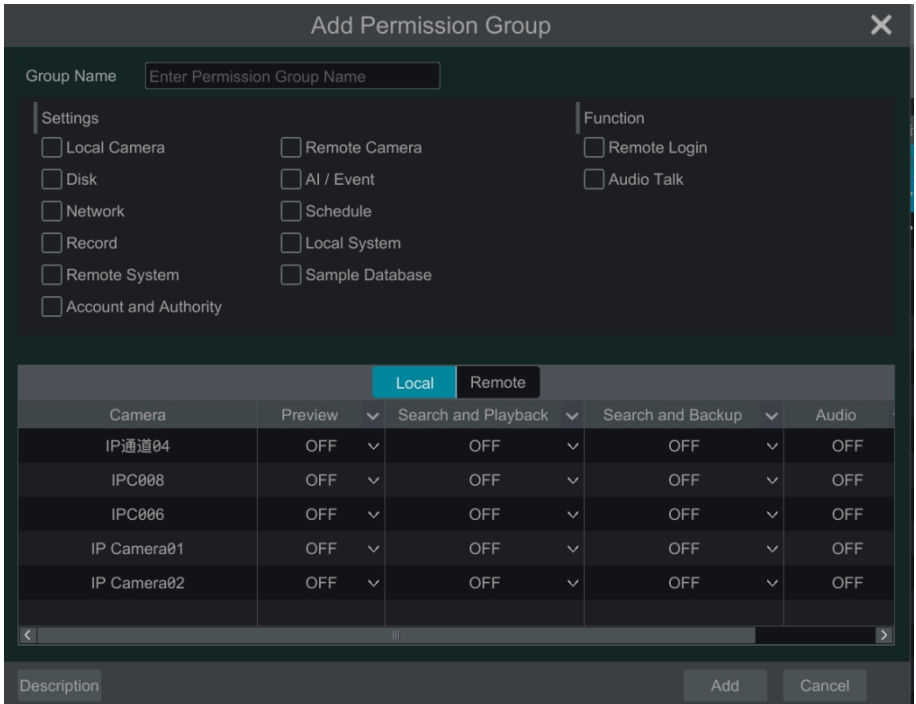

Click  to add permission group. Set the group name, check the permissions as required and then set the “Local” and “Remote” permissions. Click “Add” to save the settings.





12.3.2 Edit Permission Group

Go to “Edit Permission Group” interface and then click  in the group list to edit the permission group (the operations of the “Edit Permission Group” are similar to that of the “Add Permission Group”, please see [12.3.1 Add Permission Group](#) for details). Click  to save the group as another group. Click  to delete the permission group. The three default permission groups (“Administrator”, “Advanced” and “Common”) cannot be deleted.

12.4 Black and White List

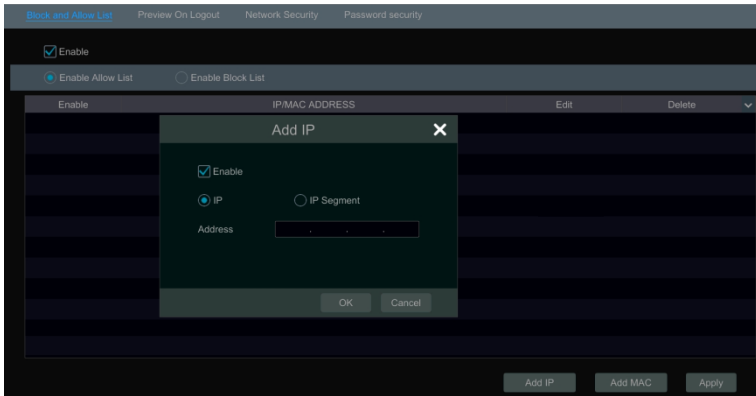
- ① Click Start→Settings→Account and Authority→Security to go to the following interface.



- ② Check “Enable” and then choose “Enable Allow List (white list)” or “Enable Block List (black list)” (the PC client of which the IP address is in the white list can access NVR remotely while the PC client in the black list cannot).
- ③ Add IP/IP segment/MAC. Click “Add IP” or “Add MAC” and then check “Enable” in the popup window (only if you check it can the IP/IP segment/MAC you add be effective). Enter the IP/IP segment/MAC and then click “OK”. In the above interface, click  to edit IP/IP segment/MAC, click  to delete it. Click “Apply” to save the settings.

12.5 Preview on Logout

Click Start→Settings→Account and Authority→Security→Preview on Logout to go to the following interface.

Set a camera and then enable or disable the preview permission on logout as required. If a camera’s preview permission on logout is “ON”, you can view the live image of the camera when the system is logged out, or the live image of the camera cannot be seen when logged out.



12.6 Network Security

Click Start→Settings→Account and Authority→Security→Network Security to go to the

following interface. You can enable APR Guard.

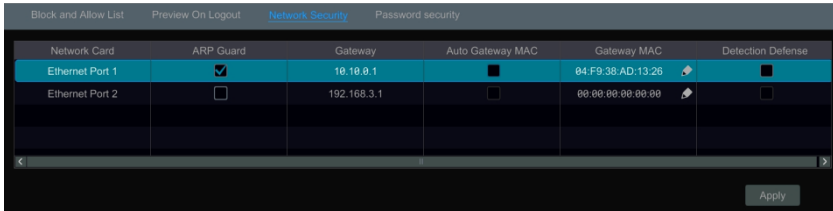

ARP Guard: Address Resolution Protocol Guard. This function can protect the LAN from APR attack and make the network run stably. If it is enabled, you can enable auto gateway MAC or manually set gateway MAC. Additionally, detection defense also can be enabled as needed.

12.7 Password Security

Click Start→Settings→Account and Authority→Security→Password Security to go to the following interface.



In this interface, you can set the level and expiration time of the password.

12.8 View Online User

Click Start→Settings→Account and Authority→User Status to view the online user information (you can view the online user name, login type, IP address and login time; click  to pop up a window showing the preview occupied channel number and playback occupied channel number).

13 Device Management

13.1 Network Configuration

13.1.1 TCP/IP Configuration

Click Start→Settings→Network→TCP/IP to go to the following interface. Check “Obtain an IP address automatically”, and “Obtain DNS automatically” to get the IPv4/IPv6 (if IPv6 is enabled) address automatically, or manually enter the network addresses. You can click “Advanced” to modify the MTU value according to the network condition (MTU, Maximum Transmission Unit, can be modified according to network condition for higher network transmission efficiency). Click “Apply” to save the settings.

The screenshot displays the 'IP Address Settings' window for 'Ethernet Port 1 (Online)'. At the top, there is a status bar with 'Ethernet Port 1 (Online)' and an 'Advanced' button. Below this, there are two main sections: IPv4 and IPv6. The IPv4 section includes a checkbox for 'Obtain an IP address automatically' (unchecked), and fields for 'Address' (10.20.52.200), 'Subnet Mask' (255.255.0.0), 'Gateway' (10.20.0.1), 'Obtain DNS automatically' (unchecked), 'Preferred DNS' (8.8.8.8), and 'Alternate DNS'. The IPv6 section includes a checked 'Enable' checkbox, and fields for 'Address' (fe80::ffff:192:168:2:200), 'Mask Length' (64), 'Gateway' (fe80::ffff:192:168:2:1), 'Obtain IPv6 DNS automatically' (unchecked), 'Preferred DNS', and 'Alternate DNS'. At the bottom, there is a 'Default Route' dropdown menu set to 'Ethernet Port 1' and an 'Apply' button.

Note:

- **Internal Ethernet Port**

If you use the NVR with the PoE network ports, click “Internal Ethernet Port” to go to the following interface.

The internal Ethernet port is the port which is used to connect all the PoE ports with the NVR system. The PoE ports are available if the internal Ethernet port is online; if it is offline, all the PoE ports will be unavailable, may be the internal Ethernet port is broken. The network addresses of the internal Ethernet port can be changed to make the port in the same network segment with the IP cameras which are directly connected to the PoE ports of the NVR (it is not recommended to change the network addresses of the internal Ethernet port).

Mode: Non-long line mode or long line mode can be selectable. The non-line mode is the default setting. If the transmission performance of your network cables connected the PoE ports and IPC are not so good or these network cables are very long, you can choose long line mode.

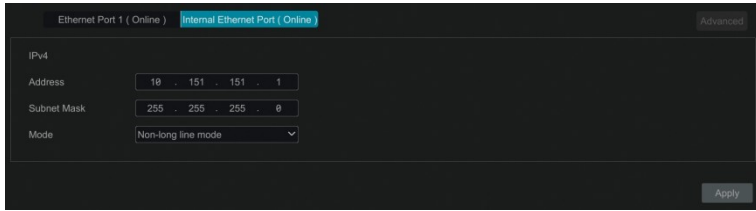

● Multiple Ethernet Ports Setting

If the NVR has two network ports or above, you can select the network work pattern as required.

TOE: Some models may support TOE mode. It is a technology for improving the network transmission speed. Please enable it according to the actual network situation. If TOE is enabled, it shall be high speed mode. Then multiple address setting or network fault tolerance can be chosen and configured. If TOE is not enabled, it shall be compatible mode. Then the network fault tolerance cannot be selected and set up.

Network Fault Tolerance:

The two network ports will be bound to one IP address if you select the “Network Fault Tolerance” pattern. There are many advantages of this work pattern: 1. increase the bandwidth; 2. form a network redundant array to share the load. When a failure happens to one network port, the other port will take over the entire load immediately. The takeover process is seamless and the network service will not be broken off.

Refer to the figure as shown below. If “Network Fault Tolerance” is selected, check “Obtain an IPv4 address automatically”, and “Obtain DNS automatically” to get the network addresses automatically, or manually enter IPv4/IPv6(if IPv6 is enabled) address select one Ethernet port as the primary card and then click “Apply” to save the settings.

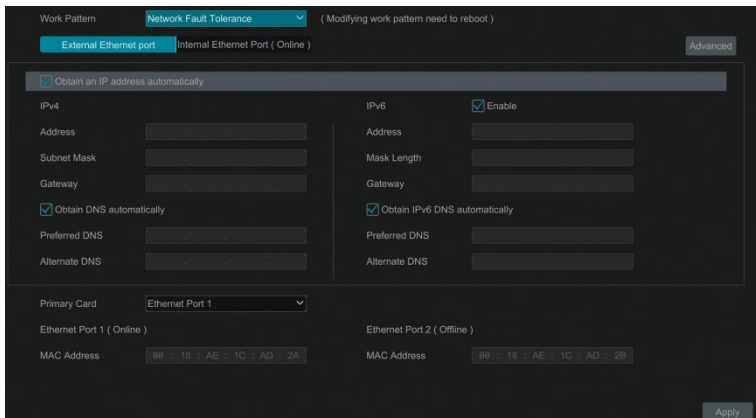

Multiple Address Setting:

If “Multiple Address Setting” is selected, the IP addresses of the two Ethernet ports should be set respectively. Refer to the picture as shown below.

Check “Obtain an IP address automatically” and “Obtain DNS automatically” to get the network addresses automatically, or manually enter IPv4/IPv6(if IPv6 is enabled) address; select one Ethernet port as the default route and then click “Apply” to save the settings.

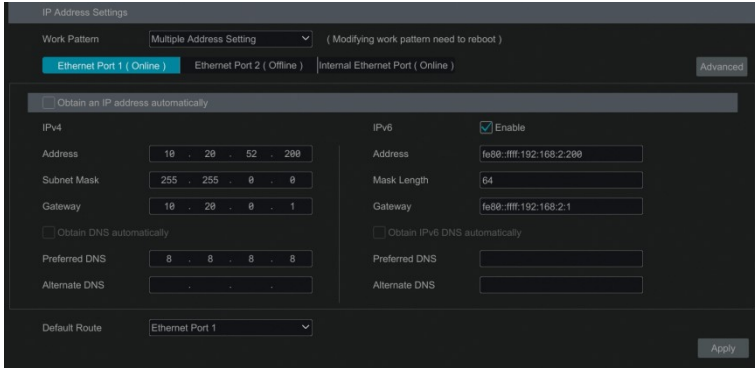

13.1.2 Port Configuration

Click Start→Settings→Network→Port to go to the interface as shown below. Enter the HTTP port, HTTPS port, server port and POS port of the NVR, and then click “Apply” to save the settings. You can also enable and set RTSP port (please check “Anonymous” as required).

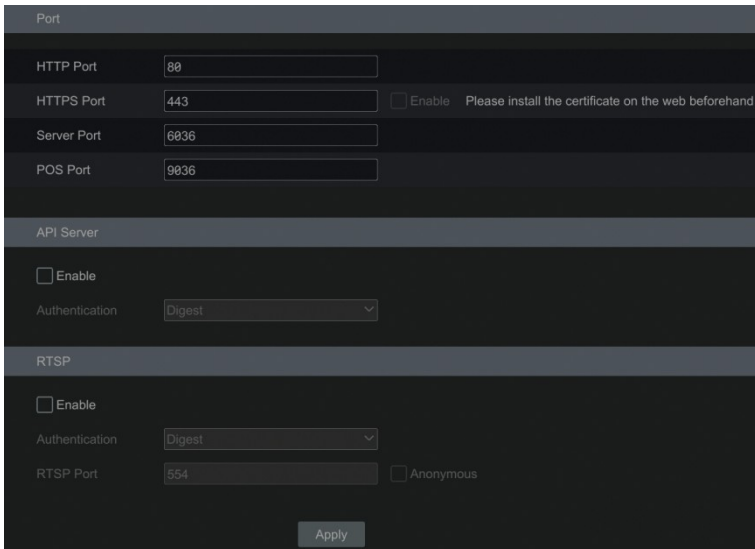

HTTP Port: the default HTTP port of the NVR is 80. The port number can be changed to others like 81. The port is mainly used to web client access. If you want to access the NVR through a web browser, you should enter IP address plus HTTP port in the address bar of the web browser like <http://192.168.11.61:81>.

Note: The HTTP port and server port of the NVR should be mapped to the router before you access the NVR via WAN.

HTTPS Port: the default HTTPS port of the NVR is 443.

HTTPS provides authentication of the web site and protects user privacy. You can enter IP address plus HTTP port in the address bar of the web browser. Then enter username and password to log in. Click Functional Panel→Network→HTTPS to go to the following interface. There are three ways to enable HTTPS service.

A. Create a private certificate.

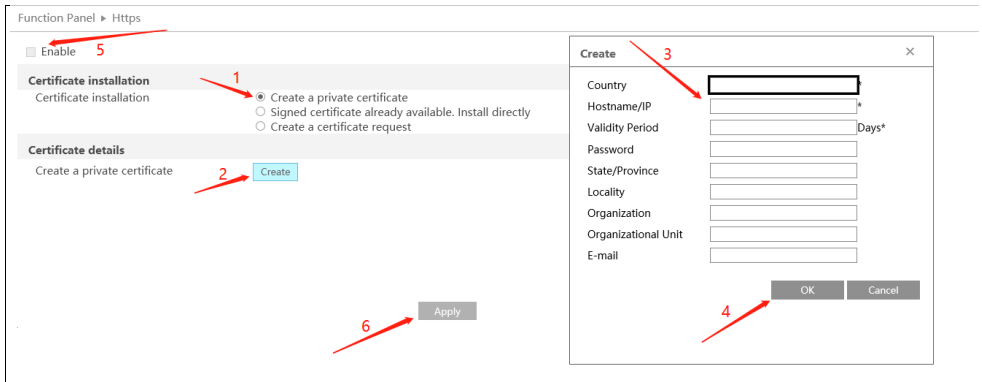

- ① Select “Create a private certificate”.
- ② Click “Create”.
- ③ Fill out the corresponding information in the above creation box. Enter the country (only two letters available), domain (NVR’s IP address/domain), validity date, password, province/state, region and so on.
- ④ Click “OK”.
- ⑤ Check “Enable” checkbox.
- ⑥ Click “Apply” to save the setting.

B. Install a signed certificate

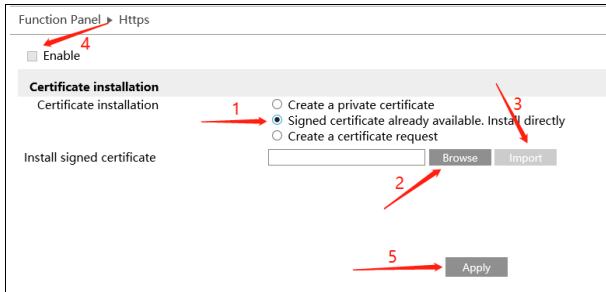

- ① Check “Signed certificate already....”.
- ② Click “Browse” to select the certificate you want to import.
- ③ Click “Import”.
- ④ Check “Enable”.
- ⑤ Click “Apply” to save the settings.

Please note that the certificate uploaded here shall be a certificate with private key.
How to attach the private key to the certificate?

Please open the certificate and the private key files with the editor (like Notepad++) and then copy the private key to the certificate.

C. Create a certificate request

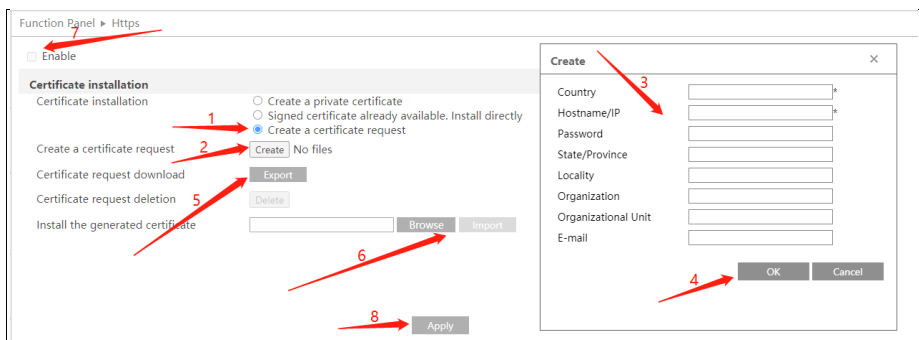

- ① Check “Create a certificate request”.
- ② Click “Create”.
- ③ Fill out the corresponding information in the above creation box. Enter the country (only two letters available), domain (NVR’s IP address/domain), validity date, password, province/state, region and so on.
- ④ Click “OK”. Then a certificate request file (CSR) will be created.
- ⑤ Click “Export” to export the certificate request file. Then send this file to the trusted third-party CA to apply a signed certificate.
- ⑥ Click “Browse” and select the signed certificate issued by the CA and then import this

certificate.

- ⑦ Click “Enable”.
- ⑧ Click “Apply” to save the settings.

After that, the device can be accessed by entering `https://IP: https port` via the web browser (eg. `https://192.168.1.201:443`).

Server Port: the default server port of the NVR is 6036. The server port number can be changed as required. The port is mainly used in network video management system.

POS Port: the default POS port of the NVR is 9036.

API Server: You can log in the media player which supports the RTSP protocol. Moreover, the third-party can further develop through API service.

Authentication: Basic authentication and digest authentication are optional.

RTSP Port: RTSP real-time stream protocol can be used to control the sending of real-time data. By media player (like VLC player) which supports the RTSP real-time stream protocol, you can view the live images synchronously. The default RTSP port is 554 and it can be changed as needed. (The address format: `rtsp://IP address:554/chID=1&streamType=main` or `rtsp://IP address:554/chID=1&streamType=sub`; main indicators main stream; sub indicators sub stream; chID indicators channel ID).

Examples: Enable RTSP and “Anonymous”. Then open the VLC player and enter the address (for example: `rtsp://192.168.1.88:554/chID=1&streamType=main`) in the network address bar of the VLC player. Then you can view the video of channel 1.

13.1.3 PPPoE Configuration

Click Start→Settings→Network→PPPoE to go to the interface as shown below. Check “Enable” in “PPPoE Settings” and then enter the username and password obtained from the dealer. Click “Apply” to save the settings.

The screenshot shows the 'PPPoE Settings' configuration window. At the top, the title 'PPPoE Settings' is displayed. Below the title, there is a checked checkbox labeled 'Enable'. Underneath, there are two input fields: 'Username' with the text 'abc' and 'Password' with six dots representing masked characters. At the bottom right corner of the window, there is a button labeled 'Apply'.

13.1.4 DDNS Configuration

The DDNS is used to control the dynamic IP address through domain name. You can access to the NVR easily if the DDNS is enabled and configured.

Click Start→Settings→Network→DDNS to go to the interface as shown below.

Check “Enable” and then select the DDNS type. Enter the server address, domain name, username and password according to the selected DDNS type. Click “Test” to test the effectiveness of the input information. Click “Apply” to save the settings. After that, the successful connection status can be viewed.

Note: Only when the DDNS type is “dyndns”, can the heartbeat interval be configurable.

You will have to enter the server address and domain name if some DDNS types are selected. Go to the relative DNS website to register domain name and then enter the registered domain information here). Now we take **www.dvrddns.com** for example.

① Enter **www.dvrddns.com** in the address bar to visit its DNS website.

② Click **Registration** to go to the interface as shown below. Set the DDNS account information (username, password and so on) and then click **Submit** to save the account.

DDNS account creation.

NEW USER REGISTRATION

USER NAME	<input type="text"/>
PASSWORD	<input type="password"/> ?
PASSWORD CONFIRM	<input type="password"/>
FIRST NAME	<input type="text"/>
LAST NAME	<input type="text"/>
SECURITY QUESTION.	My first phone number. ▾
ANSWER	<input type="text"/>
CONFIRM YOU'RE HUMAN	<div style="text-align: center;">7+1=</div> <div style="text-align: center; color: red;">New Captcha</div> <input type="text"/> <p style="font-size: small;">Solve the problem above.</p>

Already have an account? [Click here to logon.](#)

- ③ Create domain name and then click **Request Domain**.

Domain Name Creation

Enter a new domain name below.

You must create a domain name to continue.

Domain name must start with (a-z, 0-9), must be least 3 char! Cannot end or start, but may contain a hyphen and is not case-sensitive.

.dvrddns.com ▾

- ④ After you successfully request your domain name, you will see your domain name information in the list.

My Domains

Your domain names are listed below. Choose create new domain to add additional domain names.

Your domain was successfully created.

Click a name to edit your domain settings.

NAME	STATUS	DOMAIN
REDSUNSHINE	✔	redsunshine.dvrddns.com
Last Update: <i>Not yet updated</i> IP Address: 210.21.229.138		

Create additional domain names

[1]

- ⑤ Click Start→Settings→Network→DDNS to go to DDNS setting interface. Enable DDNS

and then select the *www.dvrdydns.com* DDNS type. Enter the registered username, password and domain name and then click “Apply”.

⑥ Map the IP address and HTTP port in the router (you can skip this step if UPnP function is enabled).

⑦ Enter the registered domain name plus HTTP port like *http://www.xxx.dvrdydns.com:81* in the address bar and then press Enter key to go to the web client.

13.1.5 E-mail Configuration

Click Start→Settings→Network→E-mail to go to the following interface.

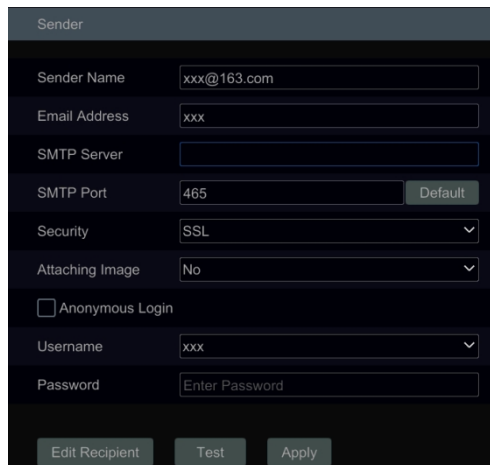

Sender	
Sender Name	xxx@163.com
Email Address	xxx
SMTP Server	
SMTP Port	465 Default
Security	SSL
Attaching Image	No
<input type="checkbox"/> Anonymous Login	
Username	xxx
Password	Enter Password
Edit Recipient Test Apply	

Enter the sender’s name, e-mail address, SMTP server and SMTP port (you can click “Default” to reset the SMTP port to the default value) and then enable or disable the SSL and attaching image. Select the username (the username list will be updated automatically according to the email address you enter) and enter the password of the sender and then click “Apply” to save the settings (you don’t have to enter the username and password if “Anonymous Login” is enabled). Click “Test” to pop up a window. Enter the e-mail address of the recipient in the window and then click “OK”. The e-mail address of the sender will send an e-mail to the recipient. If the e-mail is sent successfully, it indicates that the e-mail address of the sender is configured correctly.

Click “Edit Recipient” to go to the following interface.

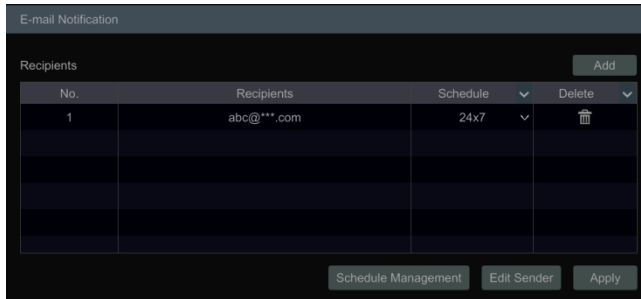

Click “Add” and then enter the recipient’s e-mail address and select the schedule (if a schedule is selected, the system will send the alarm email and the recipient will receive it only in the selected schedule time) in the popup window. Click “Add” in the window to add the recipient. You can also change the recipient’s receiving schedule by clicking in the “Schedule” column. Click to delete the recipient in the list. Click “Apply” to save the settings. Click “Edit Sender” to go to the e-mail configuration interface of the sender.

13.1.6 UPnP Configuration

By UPnP you can access the NVR through web client which is in WAN via router without port mapping.

- ① Click Start→Settings→Network→UPnP to go to the following interface.
- ② Make sure the router supports UPnP function and the UPnP is enabled in the router.
- ③ Set the NVR’s IP address, subnet mask and gateway and so on corresponding to the router.
- ④ Check “Enable” in the interface as shown below and then click “Apply”.

Click the “Refresh” button to refresh the UPnP status. If the UPnP status is “Invalid UPnP” after refreshing it a few times, the port number may be wrong. Please change the mapping type to “Manual” and then click to modify the port until the UPnP status turns to “Valid UPnP”. Refer to the following picture. You can view the external IP address of the NVR. Enter the external IP address plus port in the address bar to access the NVR such as <http://183.17.254.19:81>.

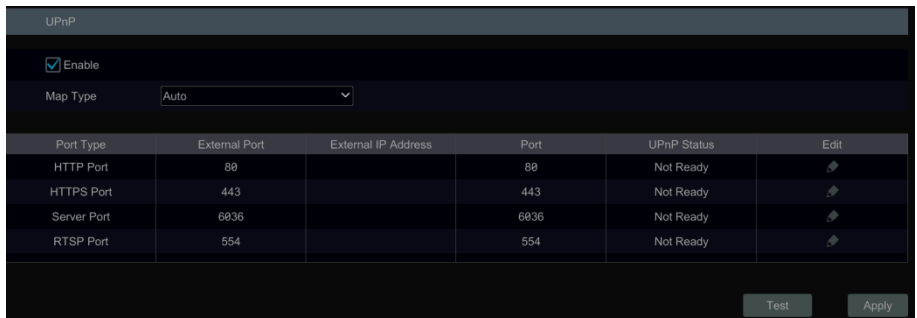

13.1.7 802.1X

If it is enabled, the NVR data can be protected. When the NVR is connected to the network protected by the IEEE 802.1X, user authentication is needed.

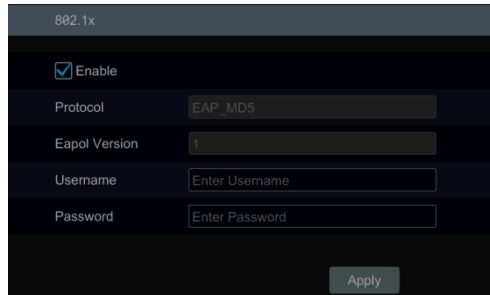

To use this function, the NVR shall be connected to a switch supporting 802.1x protocol. The switch can be considered as an authentication system to identify the device in a local network. If the NVR connected to the network interface of the switch has passed the authentication of the switch, it can be accessed via the local network.

Protocol type and EAPOL version: Please use the default settings.

User name and password: The user name and password must be the same with the user name and password applied for and registered in the authentication server.

13.1.8 NAT Configuration

Click Start→Settings→Network→NAT to go to the interface for NAT configuration. Check “Enable” and then select the NAT server address. Click “Apply” to save the settings.

You can scan the QRCode through mobile APP which is installed in the mobile phone or tablet PC to quickly add the device to the server list of the mobile APP.

Access Type: NAT or NAT2.0 can be selected.

Note:

1. If you want to use cloud upgrade, you must enable NAT2.0.
2. After the NAT and the dynamic code are enabled, use the mobile APP to scan the QRcode and then the device can be added to the server list of the mobile APP by entering the correct dynamic code. If the dynamic code is disabled, use the mobile APP to scan the QRcode, the device will be added to the server list of the mobile APP immediately without entering any password.
3. The device can be added to the account of the mobile APP only when NAT2.0 is enabled. After the NAT2.0 is enabled, when you add the device to the account of the mobile APP, you must enter the security code of the device here. Please refer to the mobile surveillance user manual for details.

13.1.9 FTP Configuration

Some models may not support this function.

Click Start→Settings→Network→FTP to go to the interface for FTP configuration. Check “Enable” and enter the server name, port, username and password, max file size and remote directory.

Please enable “Resume Uploading” as needed.

After that, you can choose the video records, images and alarm information to upload as needed in this interface.

No.	Camera Name	Schedule	Motion	Intelligence	Sensor	Stream Type	Uploading Image	Uploading File(txt)
1	IP Camera01	24x7	OFF	OFF	OFF	Sub Stream	OFF	OFF

13.1.10 SNMP

- ① Click Start→Settings→Network→SNMP to go to the interface for SNMP configuration.

- ② Check SNMPv1 or SNMPv2 to enable this function.
- ③ Set the port of the SNMP.
- ④ Set the trap address and the trap port.
- ⑤ Click “Apply” to save the settings.

Trap Address: The IP address of SNMP host.

Trap Port: The port of SNMP host.

Tips: Before setting the SNMP, please download the SNMP software and manage to receive the device information via SNMP port. By setting the trap address, the device is allowed to send the alarm event and exception message to the monitoring center.

13.1.11 Cloud Upgrade

Note: Before you use cloud upgrade, please enable NAT2.0.

- ① Click Start→Settings→Network→Cloud Upgrade as shown below.

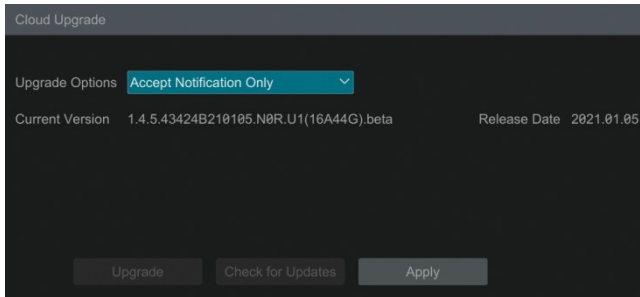

- ② Select “Accept Notification Only” or click “Check for Updates” to check whether the current version is the latest. If your software version is not the latest, click “Upgrade” to download and upgrade from the cloud server.
- ③ Please don't power off during the upgrade process.

13.1.12 Platform Access

Some models may not support this function.

This function is mainly used for connecting ECMS/NVMS. The setting steps are as follows.

Click Start→Settings→Network→Integration→Platform Access to go to the interface.

Platform Access

Access Type: Platform Software

Enable

Server Address: 192.168.1.200

Port: 2009

Report ID: Enter Report ID

Report Status: Disable

Apply

Platform Access

- ① Set “Access Type” as “Platform Software” and select “Enable” as shown below.
- ② Check the IP address and port of the transfer media server in the NVMS. The default server port for auto report is 2009. If it is modified, please go to the transfer media interface to check.
- ③ Enable the auto report in the NVMS when adding a new device. Then self-define device ID and complete the remaining information of the device in the NVMS.
- ④ Enter the above-mentioned server address, port and report ID in the server interface. Then click “Apply” to save the settings. Now the NVMS system will automatically connect this device.

13.1.13 UPnP Report Access

In this interface, you can also access the third-party platform by UPnP Report. Click Start→Settings→Network→Integration→UPnP Report. If this one is enabled, please enter the server address, port and manufacturer ID.

UPnP Report

Enable

Server Address: Enter Address

Port: 0

Manufacturer ID: Enter Manufacturer ID

Apply

13.1.14 ONVIF

The device supports ONVIF (Profile G/T) and the model name can be searched on ONVIF official website. After the ONVIF is enabled, it can be searched and connected to the third-party platform via ONVIF protocol.

Click Start→Settings→Network→Integration →ONVIF to enter the following interface.

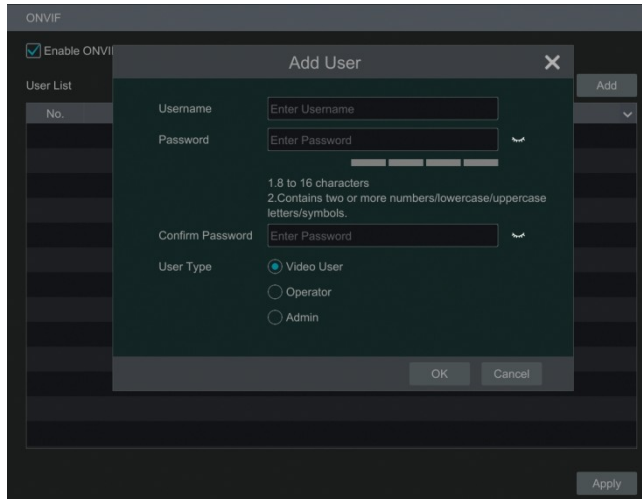

Note: when adding the device to the third-party platform with ONVIF protocol, please check “Enable ONVIF” first and then enter the username and password created in the above interface.

13.1.15 Sub Stream Settings

Click Start→Settings→Network→Sub Stream Settings to go to the following interface. In this interface, you can configure the parameters of the sub stream such as encode, resolution, FPS, Quality and so on.

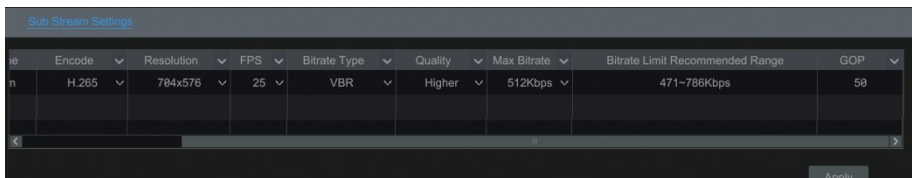

13.1.16 View Network Status

Click Start→Settings→Network→Network Status to view the network status or click  on the tool bar at the bottom of the live preview interface to view network status conveniently.

13.2 Basic Configuration

13.2.1 Common Configuration

Click Start→Settings→System→Basic→General Settings to go to the following interface. Set the device name, device No., language, video format and main output. Enable or disable wizard, “Log In Automatically”, “Log Out Automatically” (if checked, you can set the wait time), “App Live Self-Adaption” and “Dwell Automatically” (if checked, you can set the wait time). Click “Apply” to save the settings.

General Settings

Device Name: Device Name

Device No.: 1

Language: English

Video Format: NTSC

Fixed display resolution

Main Output: 1920x1080

Secondary Output: 1920x1080

Enable Wizard

Log In Automatically

Log Out Automatically

Wait Time: 1 Min

App Live Self-adaption

Dwell Automatically

Wait Time: 10 Mins

Apply

Device Name: The name of the device. It may display on the client end or CMS that help user to recognize the device remotely.

Video Format: Two modes: PAL and NTSC. Select the video format according to the camera.

Main Output: Enable “Fixed display resolution” and then select the main output as needed.

Note: You can set the resolutions of the main output and secondary output respectively if the NVR has dual outputs. Refer to the picture as shown below.

Dwell Automatically: Switch automatically. Check it and set “wait time”.The system will switch images automatically if it is not operated during the time you set.

13.2.2 Date and Time Configuration

Click Start→Settings→System→Basic→Date and Time to go to the interface as shown below. Set the system time, date format, time format and time zone of the NVR. The default time zone is GMT+08 Beijing, Hong Kong, Shanghai, Taipei. If the selected time zone includes DST, the DST of the time zone will be checked by default. Click “Apply” to save the settings.

You can manually set the system time or synchronize system time with network through NTP.

Manual: select “Manual” in the “Synchronous” option and then click  after the “System Time” option to set the system time.

NTP: select “NTP” in the “Synchronous” option and then enter the NTP server.

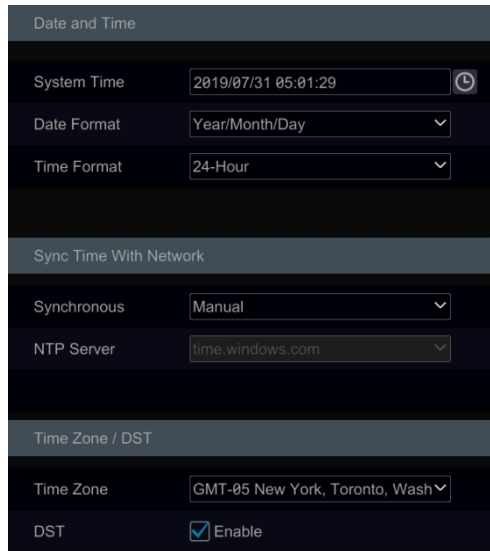

Date and Time	
System Time	2019/07/31 05:01:29 
Date Format	Year/Month/Day
Time Format	24-Hour
Sync Time With Network	
Synchronous	Manual
NTP Server	time.windows.com
Time Zone / DST	
Time Zone	GMT-05 New York, Toronto, Wash
DST	<input checked="" type="checkbox"/> Enable

13.2.3 Recorder OSD Settings

Click Start→Settings→System→Basic→Recorder OSD settings to go to recorder OSD setting interface. OSD name and icon can be enabled here.

13.2.4 PoE Power Management

Click Start→Settings→System→Basic Settings→PoE Power Management to go to the following interface. This function is only available for the POE device.

PoE Port	Enable	Current Power
Poe[01]	ON	0.00W
Poe[02]	ON	0.00W
Poe[03]	ON	0.00W
Poe[04]	ON	0.00W
Poe[05]	ON	0.00W
Poe[06]	ON	0.00W
Poe[07]	ON	0.00W
Poe[08]	ON	0.00W

In this interface, you can view the the current power consumption of the added POE camera/panel. The PoE power supply of the PoE camera/panel can be enabled or disabled by selecting “ON” or “OFF” as needed.

13.3 Factory Default

Click Start→Settings→System→Maintenance→Factory Default to go to the following interface. Please choose the item as needed.

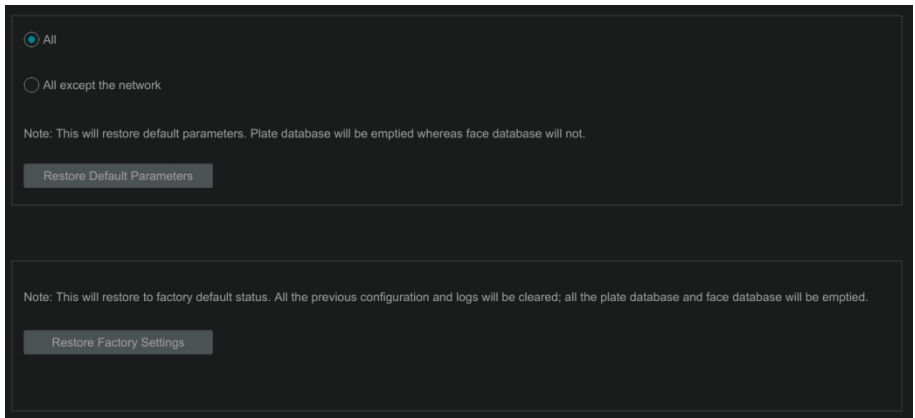

Note: Restoring default parameters will not change time zone and video format, except that, the password of the admin will be kept.

13.4 Device Software Upgrade

● Upgrade

You can click Start→Settings→System→Information→Basic to view MCU, kernel version and firmware version and so on. Before upgrade, please get the upgrade file from your dealer.

The upgrade steps are as follows:

- ① Copy the upgrade software (.tar) into the USB storage device.
- ② Insert the USB storage device into the USB interface of the NVR.
- ③ Click Start→Settings→System→Maintenance→Upgrade to go to “Upgrade” interface.

Select the USB device in “Device Name” option and go to the path where the upgrade software exists. Select the upgrade software and then click “Upgrade”. The system may automatically restart during upgrading. Please wait for a while and do not power off the NVR during upgrading.

Note: The file system of the USB mobile device which is used for upgrading, backing up and restoring should be FAT32/NTFS format.

13.5 Backup and Restore

You can back up the configuration file of the NVR by exporting the file to other storage devices; you can recover the configuration to other NVRs which are of the same model with the NVR by importing the configuration file to other NVRs for time saving.

Insert the USB storage device into the USB interface of the NVR and then click Start→Settings→System→Maintenance→Backup and Restore to go to the interface.

- **Backup**

Select the USB device in “Device Name” option; go to the path where you want to store the configuration backup file and then click “Backup”; finally click “OK” in the popup window.

- **Recover**

Select the USB device in “Device Name” option; find the configuration backup file and then click “Recover”; finally click “OK” in the popup window.

13.6 Restart Automatically

You can set the automatic restart time for the NVR to maintain it regularly. Click Start→Settings→System→Maintenance→Auto Maintenance to go to the interface as shown below. Enable auto maintenance, set the interval days and point of time and then click “Apply” to save the settings. The NVR will restart automatically at the pointed time every interval days.

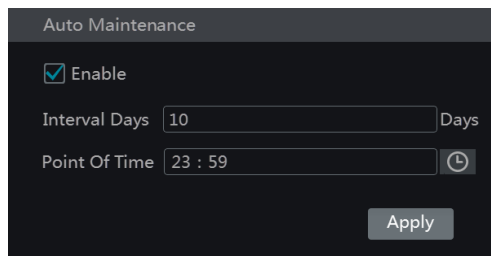

Auto Maintenance

Enable

Interval Days Days

Point Of Time ⌚









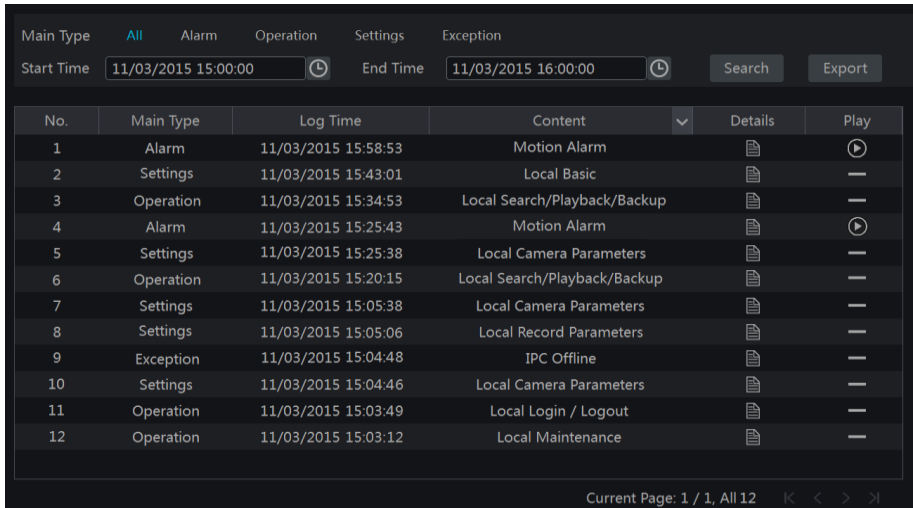





Apply



13.7 View Log

Click Start→Settings→System→Maintenance→View Log to go to the log view interface.

Select the log main type, click  to set start time and end time and then click “Search”. The searched log files will be displayed in the list.



No.	Main Type	Log Time	Content	Details	Play
1	Alarm	11/03/2015 15:58:53	Motion Alarm		
2	Settings	11/03/2015 15:43:01	Local Basic		—
3	Operation	11/03/2015 15:34:53	Local Search/Playback/Backup		—
4	Alarm	11/03/2015 15:25:43	Motion Alarm		
5	Settings	11/03/2015 15:25:38	Local Camera Parameters		—
6	Operation	11/03/2015 15:20:15	Local Search/Playback/Backup		—
7	Settings	11/03/2015 15:05:38	Local Camera Parameters		—
8	Settings	11/03/2015 15:05:06	Local Record Parameters		—
9	Exception	11/03/2015 15:04:48	IPC Offline		—
10	Settings	11/03/2015 15:04:46	Local Camera Parameters		—
11	Operation	11/03/2015 15:03:49	Local Login / Logout		—
12	Operation	11/03/2015 15:03:12	Local Maintenance		—

Choose the log file in the list and then click “Export” button to export the log file. Click  on the “Content” title bar to pop up a menu list. Check contents in the menu list and then the log list will show the checked log contents only. Click  to play the video log.

13.8 View System Information

Click Start→Settings→System→Information and then click the corresponding menu to view the “Basic”, “Camera Status”, “Alarm Status”, “Record Status”, “Network Status” and “Disk” information of the system.

14 Remote Surveillance

14.1 Mobile Client Surveillance

- ① Enable NAT in the NVR. Refer to [13.1.8 NAT Configuration](#) for details.
- ② Download and install the mobile client “SuperLive Plus” into the mobile device with the Android or iOS system.
- ③ Run the mobile client, go to the “Server List” interface and then click  to scan the QRCode of the NVR (Go to Start→Settings→Network→NAT to view the QRCode of the NVR).

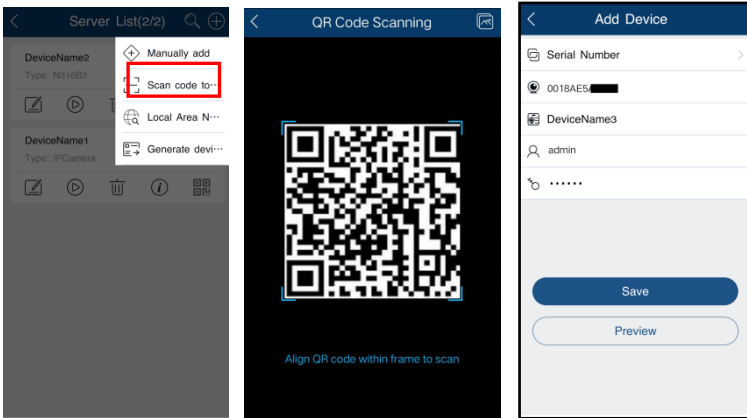

If the dynamic code of the NVR is enabled, you shall enter the dynamic code when adding the device to the server list of the mobile APP. If the dynamic code is not enabled, the device will be added immediately after scanning the QRcode. If you want to add the device to the account of the mobile APP, you must enable NAT2.0 and enter the security code. Please refer to the mobile surveillance user manual for details.

14.2 Web LAN Access

- ① Click Start→Settings→Network→TCP/IP to go to the “TCP/IP” interface. Set the IP address, subnet mask, gateway, preferred DNS and alternate DNS of the NVR.
- ② Open a web browser on your computer, enter the IP address of the NVR in the address bar and then press enter to go to the login interface as shown below. You can change the display language on the top right corner of the login interface. Enter the username and password of the NVR in the interface and then click “Login” to go to the live preview interface.

Notes:

1. Please make sure that the IP address of the NVR and the computer are both in the same local network segment. For example, supposing that the IP address of the computer is 192.168.1.41, the IP address of the NVR shall be set to 192.168.1.XXX.
2. If the HTTP port of the NVR is not 80, but other number instead, you need to enter the IP address plus port number in the address bar when accessing the NVR over network. For example, the HTTP port is 81. You should enter `http://192.168.1.42:81` in the address bar.

14.3 Web WAN Access

➤ NAT Access

- ① Set the network of the NVR. Please refer to [13.1.1 TCP/IP Configuration](#) for details.
- ② Enable NAT and then set the NAT server address. Please refer to [13.1.8 NAT Configuration](#) for details.
- ③ Open a web browser on your computer, enter the NAT server address **www.autonat.com** in the address bar and then press enter to go to the interface as shown below (download and install the relative plug-in according to the tip if you access the NVR through NAT for the first time).

Enter the serial number (click  on the tool bar at the bottom of the live preview interface to see the serial number of the NVR), user name (the user name of the NVR, **admin** by default) and password of the NVR, select the display language on the top right corner of the interface and then click “Login” to go to the web client interface.

➤ PPPoE Access

- ① Click Start→Settings→Network→PPPoE to go to the “PPPoE” interface. Check “Enable” in the “PPPoE settings” and then enter the username and password you get from your ISP. Click “Apply” to save the settings.
- ② Click Start→Settings→Network→Network Status to view the IP address of the NVR.
- ③ Open a web browser on your computer, enter the IP address of the NVR like `http://210.21.229.138` in the address bar and then press enter to go to the login interface. Enter the username and password of the NVR in the interface and then click “Login” to go to the live preview interface.

➤ Router Access

- ① Click Start→Settings→Network→TCP/IP to go to the “TCP/IP” interface. Set the IP address, subnet mask, gateway, preferred DNS and alternate DNS of the NVR.
- ② Set the HTTP port (it is suggested to modify the HTTP port because the default HTTP port 80 might be taken up) and enable UPnP function in both the NVR and the router. If the UPnP function is not available in the router, you need to forward the LAN IP address, HTTP port and server port of the NVR to the router. Port mapping settings may be different in different routers, so please refer to the user manual of the router for details.
- ③ Get the WAN IP address of the NVR from the router. Open a web browser on your computer, enter the WAN IP address plus HTTP port like `http://116.30.18.215:100` in the address bar and then press enter to go to the login interface. Enter the username and password of the NVR in the interface and then click “Login” to go to the live preview interface.

Note: If the WAN IP address is a dynamic IP address, it is necessary for you to use the domain name to access the NVR. Click Start→Settings→Network→DDNS to set DDNS (see [13.1.4 DDNS Configuration](#) for details). By using DDNS function you can use the domain name plus HTTP port like `http://sunshine.dvrddns.com:100` to access the NVR via internet.

14.4 Web Remote Control

The NVR supports web client access with plug-in or without plug-in.

The supported browsers for remote access are IE8/9/10/11, Firefox, Opera and Chrome in Windows system and Safari in MAC system.

The supported browsers (green color) for remote access without the plug-in are as follows.

IE	Edge	Firefox	Chrome	Safari	Opera	iOS Safari	Opera Mini	Android Browser	Opera Mobile	Chrome for Android	Firefox for Android	UC Browser for Android	Samsung Internet	QQ Browser	Baidu Browser	KaiOS Browser
		2-46														
12-14	15	47-51	4-50		10-37											
6-10	16-84	52	51-56	3.1-10.1	38-43	3.2-10.3							4-6.4			
11	85	80	85	14	70	14.0	all	2.1-4.4.4	12-12.1				7.2-11.2			
		81-82	86-88	TP				81	59	85	79	12.12	12.0	10.4	7.12	2.5

When you access the NVR through web client for the first time, some browsers need to download and install the relative components for normal preview and playback.

Please refer to the tips in the remote interfaces for details. The buttons and icons on the top right corner of the remote interface are introduced as follows.

admin: the current login username.

Logout: click it to log out and return to the login interface.

Modify Password: click it to change the password of the current login user. Enter the current password and then set a new password in the popup window. Click “OK” to save the new password.

Local Settings: click it to change the local settings. Set the snapshot number and click “Browse” to set the snapshot path and record path as shown below. Click “Apply” to save the settings.

Snapshots number

Save snapshots to

Save record files to

14.4.1 Remote Preview

Click “Live Display” in the remote interface to go to the preview interface.

➤ For the web client with the plug-in

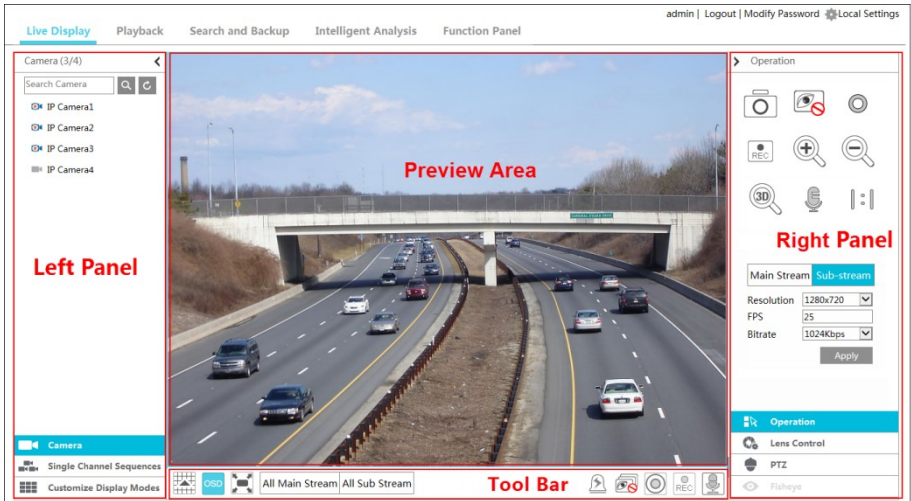

The preview interface consists of the four areas marked in the following picture.





➤ Start Preview

Select a window in the preview area and then click one online camera on the left panel to preview the camera in the window. You can click  in the tool bar to preview all the cameras.

➤ Left Panel Introduction

Click  on the left panel to hide the panel and click  to show the panel. You can view all the added cameras and groups on the left panel.

● View Camera

Click  **Camera** to view the cameras. You can view the number of all the added cameras and the online cameras. For instance, the left number 3 in **Camera (3/4)** on the left panel stands for the number of online cameras; the right number 4 stands for the number of all the added cameras. Enter the camera name in the search box and then click  to search the camera. Click  to refresh the camera list.











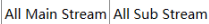

● View Group

Click  **Single Channel Sequences** to view the groups. The up side of the left panel displays all the groups and the down side displays all the cameras in the group.







● View Scheme



Click  **Customize Display Modes** to view the scheme. All schemes can be shown in the left panel. Double click the scheme name to invoke it quickly.

➤ Tool Bar Introduction









Button	Meaning
	Screen mode button.
	Click it to disable OSD. Click  to enable OSD.
	Click it to show full screen. Right click on the full screen to exit full screen.
	Click “All Main Stream” or “All Sub Stream” to set the stream of all the cameras.
	Manual alarm button. Click it to pop up a window and then trigger and clear the alarm-out in the window manually.
	Click it to preview all the cameras.
	Click it to close all the preview cameras.
	Click it to start recording for all cameras to computer. Click  to stop recording.
	Click it to start recording for all cameras to the NVR. Click  to stop recording.
	Click it to enable talk with the NVR.



➤ Right Panel Introduction

Click  on the right panel to show the panel and click  to hide the panel. Click  PTZ at the bottom of the panel to go to “PTZ” panel. Click  Operation to go to “Operation” panel. Click  Lens Control to go to “Lens Control” panel. Click  Fisheye to go to “Fisheye” panel.











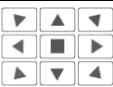









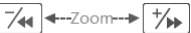

Click one camera window in the preview area and then click  Main Stream to set the camera’s live preview stream and record stream to main stream in manual record mode; click  Sub-stream to set the camera’s live preview stream and record stream to sub stream. In sub stream tab, set the resolution, FPS and bitrate and then click “Apply” to save the settings.

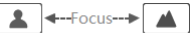
Operation panel introduction:

Button	Meaning
	Click it to snap.
	Click it to start record to computer
	Click it to start record to the NVR.
	Click it to zoom in the image of the camera and then drag the mouse on the camera image to view the hidden area.
	Click it to zoom out the image of the camera.
	Click it to start two-way talk.
	The 3D zoom in function is designed for P.T.Z. Click it and then drag the image to zoom in or zoom out the image; click the image on different areas to view the image of the dome omni-directionally.
	Click it to close the preview camera.

	Click it to display original size
	Click it to enable audio and then drag the slider bar to adjust the volume. You can listen to the camera audio by enabling audio.

PTZ panel introduction:

Button	Meaning
	Click  /  /  /  /  /  /  /  /  to rotate the dome; click  to stop rotating the dome.
	Drag the slider to adjust the rotating speed of dome.
	Click  /  to zoom in/out camera image.
	Click  /  to increase/ decrease the focal length.
	Click  /  to increase/decrease the iris of the dome.
	Click it to view the preset list and then click the button in the list to call the preset.
	Click it to view the cruise list and then click the corresponding buttons in the list to start or stop the cruise.

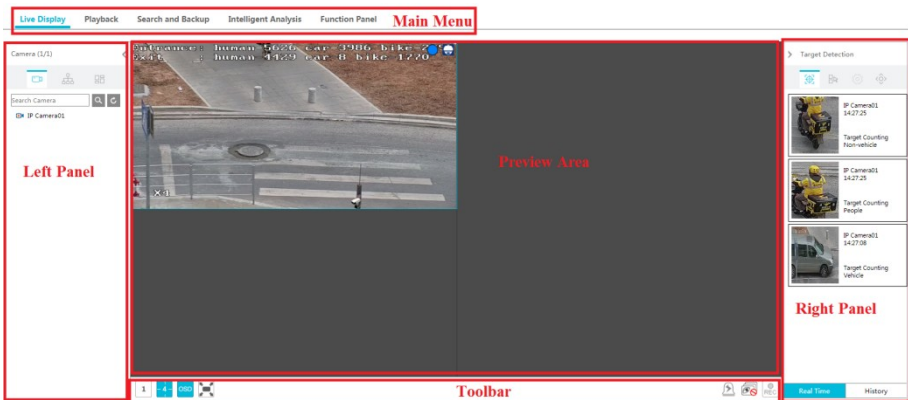

➤ For the web client without the plug-in



➤ Start Preview

Select a window in the preview area and then click one online camera on the left panel to preview the camera in the window. You can click  in the tool bar to preview all the cameras.

➤ Left Panel Introduction

Click  on the left panel to hide the panel and click  to show the panel. You can view all the added cameras and groups on the left panel.

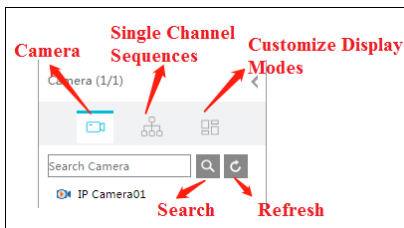

➤ Right Panel Introduction

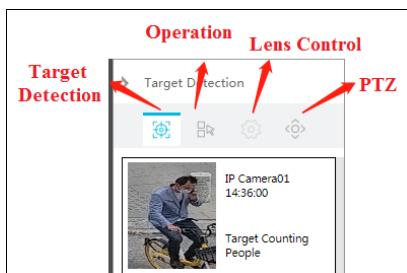

For the web client without the plug-in, you can view the real-time/history target detection, but the fisheye adjustment function is not supported. Other functions are similar to the web client with the plug-in.

14.4.2 Remote Playback











Click “Playback” in the remote interface to go to the playback interface.

- ① Check the record event types and cameras on the left panel. Set the record date on the calendar beside the time scale.
- ② Click to search the record data and then click or directly click the time scale to play the record.

The operation of the playback time scale is similar to that of the time scale in the main program of the NVR. Please refer to [8.2 Playback Interface Introduction](#) for details.

Introduction of playback control buttons:



Button	Meaning
	Stop button.
	Rewind button. Click it to play video backward.
	Play button. Click it to play video forward.
	Pause button.
	Deceleration button. Click it to decrease the playing speed.
	Acceleration button. Click it to increase the playing speed.

Button	Meaning
	Previous frame button. It works only when the forward playing is paused in single screen mode.
	Next frame button. It works only when the forward playing is paused in single screen mode.
	Click  to step backward 30s and click  to step forward 30s.
	Backup start time button. Click the time scale and then click it to set the backup start time.
	Backup end time button. Click the time scale and then click it to set the backup end time.
	Backup button.
	Backup tasks button. Click it to view the backup status.
	Event list button. Click it to view the event record of manual/schedule/sensor/motion.

14.4.3 Remote Search and Backup

Click “Search and Backup” in the remote interface to go to the backup interface. You can back up the record by event or by time.

➤ By Event

Check the record type on the left side of the interface and then click  to set the start time and end time; check the cameras and then click  on the right side to search the record (the searched record data will be displayed in the list); check the record data in the list and then click “Backup” to backup the record.

➤ By Time







Click  to set the start time and end time on the left side of the interface; check the cameras and then click  on the right side to backup the record.

Image Management: Click “Image Management” to go to image management interface. The system will display all the captured images automatically in the list. Click  to delete the image. Click  to pop up the “Export” window. Click  to pop up the “View Image” window. Click  to export the image.

View Backup Status: Click “Backup Status” to view the backup status. Click “Pause” to pause; click “Resume” to continue the backup; click “Delete” to delete the task.

14.4.4 Intelligent Analysis

This function is only available for the model with VCA (video content analysis) functions. Click “Intelligent Analysis” in the remote interface to configure smart search, statistics, face database, face attendance and face check in. All of these settings are similar to that of the NVR. See the configurations of the NVR for details.

14.4.5 Remote Configuration

Click “Function Panel” in the remote interface and then configure the camera, record, alarm,

disk, network, account and authority and system of the NVR remotely. All of these settings are similar to that of the NVR. See the configurations of the NVR for details.

➤ Jumping to IPC Web Client

A. If your NVR is a PoE NVR and the IPC is directly connected to the PoE port of the NVR, you can enable virtual host in the port setting interface via Web Client. After this function is enabled, the web settings interface of NVR can be jumped to the web client of the IPC. The setting steps are as follows.

1. Please login the Web Client of NVR (See [14.2 Web LAN Access](#) or [14.3 Web WAN Access](#) for details). Click Settings→Network→Port to go to the following page. The picture is for reference only. The interface may be different for different devices.

2. Check “Enable virtual host” and then click “Apply”.
3. Click Camera→Edit Camera to go to the following interface.

Settings									admin
Manage Camera > Edit Camera									Add Camera
No.	Camera Name	Type	Status	Device Model	Preview	Edit	Delete	Settings	
1	IPC111	Thermal Network Camera	Offline	TE-5433E					
2	9941E3	IP Camera (Entry and Exit)	Offline	TD-9442E3					
3	IPCMBJ	Facial Panel	Online	E2128					
4	IPC	Attendance Terminal	Offline	TD-9632E2					
5	伊爾達03	Attendance Terminal	Offline	S3-3MP					

4. Select the camera and click to log in the web client of the camera. Then you can set the parameters of the camera as needed.

B. If your device is a PoE NVR and the IPC is connected to the NVR via LAN/WAN, except the IPC access with RTSP protocol, the IPC can be directly jumped from the NVR web client to the IPC web client by clicking in the above-mentioned interface.

C. If your device is a non-PoE NVR, except the IPC access with RTSP protocol, the IPC can be directly jumped from the NVR web client to the IPC web client by clicking in the above-mentioned interface.

Appendix A FAQ

Q1. Why can't I find the HDD?

- a. Please check the power and SATA data cables of the HDD to make sure they are well connected.
- b. For some NVRs with the 1U or small 1U case, the power of the adapter may be not enough for operating them. Please use the power adaptor supplied along with the NVR.
- c. Please make sure the HDDs are compatible with the NVR. See [Appendix C Compatible Device List](#) for details.
- d. The HDD could have gone bad.

Q2. Why are there no images output in some or all of the camera windows?

- a. Please make sure the resolutions of the cameras are supported by the NVR.
- b. Please make sure the network cables of the IP camera and NVR are both connected properly and the network parameters are set correctly.
- c. Please make sure the network and the switch both work normally.

Q3. The screen has no output after booting the NVR normally.

- a. Please make sure the screen, HDMI or VGA cables are good and well connected.
- b. Please make sure the screen supports the resolution of 1280*1024, 1920*1080 or 3840*2160 (4K*2K). The NVR cannot self-adapt to the screen of which the resolution is lower than 1280*1024, and then the screen will remind you that the screen resolution is not supported by the NVR or just have no display. Please change a screen at 1280*1024, 1920*1080 or 3840*2160 resolution before booting the NVR.

Q4. Forget the passwords?

- a. The password for *admin* can be reset through “Edit Security Question” function. Click “Edit Security Question” in the login window and then enter the corresponding answer of the selected question in the popup window. After you correctly answer all questions, you can reset the password for *admin*. If you forget the answer of the question, this way will be invalid, please contact your dealer for help.
- b. The passwords of other users can be reset by *admin*, please refer to [12.1.2 Edit User](#) for details.

Q5. The NVR cannot add up to the maximum number of IP cameras?

Take the 16 CH NVR as an example. Some 16 CH NVR support a maximum of 120Mbps bandwidth input (please take the real device for standard). Refer to the picture below. The remaining bandwidth should be larger than the bandwidth of the IP camera you want to add, or you would fail to add the IP camera. You should lower the added cameras' bitrate to release the bandwidth. It is recommended to add cameras by “Quickly Add” for batch adding.

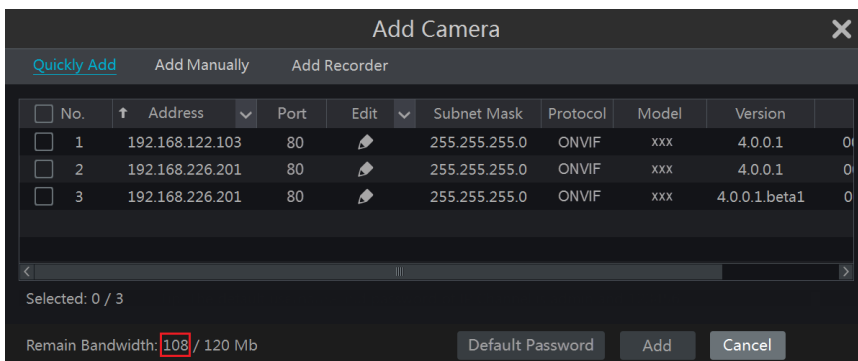

Q6. The IP camera which connects to the PoE port of the NVR cannot be displayed automatically in the camera list, why?

- Please check whether the resource of the PoE port is occupied by another IP camera that is added through network.
 - Take the 16 CH NVR with 8 PoE ports as an example. The resource distribution of the 16 CH IP cameras is shown in the picture below.

CH1	CH2	CH3	CH4	CH5	CH6	CH7	CH8	CH9	CH10	CH11	CH12	CH13	CH14	CH15	CH16
								POE-1	POE-2	POE-3	POE-4	POE-5	POE-6	POE-7	POE-8

When you add IP cameras through network, the IP cameras will occupy the resource from CH1, CH2, CH3, CH4... by the adding sequence; if you directly connect the IP cameras to the PoE ports of the NVR, the IP cameras will occupy the resource from CH9 to CH16 according to the number of the PoE port each IP camera is connecting to.

Supposing that 12 CH IP cameras have been added to the NVR through network and no IP camera has been directly connected to the PoE port. The 12 CH IP cameras occupy the 8 network resources from CH1 to CH8 and 4 PoE resources from CH9 to CH12 which are supposed to be occupied by connecting the IP cameras directly. In this situation, if you directly connect one IP camera to PoE5, PoE6, PoE7 or PoE8, the IP camera will be displayed in the camera list automatically; if you connect it to PoE1, PoE2, PoE3 or PoE4, it won't be displayed in the camera list by showing resource conflict; if you just need to connect it to PoE1, PoE2, PoE3 or PoE4, you should first delete the IP camera which occupies the PoE port resource and then reconnect it to the PoE port.

- Take the 8 CH NVR with 8 PoE ports as another example. The resource distribution of the 8 CH IP cameras is shown in the picture below and the adding rules of the IP cameras are similar to the rules mentioned in the above. Please refer to the above for details.

CH1	CH2	CH3	CH4	CH5	CH6	CH7	CH8
POE-1	POE-2	POE-3	POE-4	POE-5	POE-6	POE-7	POE-8

b. Please make sure that the internal Ethernet port and the IP camera which directly connects to the PoE port through ONVIF protocol are in the same network segment.

The internal Ethernet port and the IP camera which directly connects to the PoE port through ONVIF protocol should be in the same network segment, or you will fail to add the IP camera. Log in the IP camera's web client and then enable DHCP (obtain an IP address automatically); or manually change the IP address of the IP camera to make it in the same network segment with the internal Ethernet port.

c. Check whether the number of the added IP camera is the maximum.









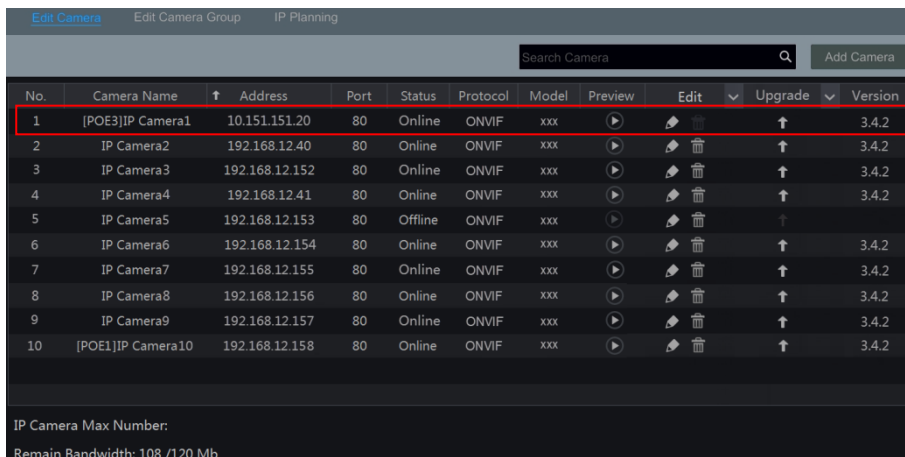





















If the number of the added IP camera is the maximum, the system will show you the message that the IP camera number is beyond the maximum when you directly connect another IP camera to the available PoE port and thus you will fail to add the IP camera.

Q7. The IP camera which directly connects to the PoE port of the NVR through ONVIF protocol is shown in the camera list, but there is no image output, why?

Please make sure the username and password of the IP camera are correct. The IP camera's username and password can be modified through the two ways mentioned as below.

① Click "Edit Camera" in the Camera module of the setup panel to go to the interface as shown below. Click  to modify the username and password of the IP camera (enter the correct username and password of the IP camera in the popup window and then click "OK").



No.	Camera Name	Address	Port	Status	Protocol	Model	Preview	Edit	Upgrade	Version
1	[POE3]IP Camera1	10.151.151.20	80	Online	ONVIF	xxx				3.4.2
2	IP Camera2	192.168.12.40	80	Online	ONVIF	xxx				3.4.2
3	IP Camera3	192.168.12.152	80	Online	ONVIF	xxx				3.4.2
4	IP Camera4	192.168.12.41	80	Online	ONVIF	xxx				3.4.2
5	IP Camera5	192.168.12.153	80	Offline	ONVIF	xxx				3.4.2
6	IP Camera6	192.168.12.154	80	Online	ONVIF	xxx				3.4.2
7	IP Camera7	192.168.12.155	80	Online	ONVIF	xxx				3.4.2
8	IP Camera8	192.168.12.156	80	Online	ONVIF	xxx				3.4.2
9	IP Camera9	192.168.12.157	80	Online	ONVIF	xxx				3.4.2
10	[POE1]IP Camera10	192.168.12.158	80	Online	ONVIF	xxx				3.4.2

IP Camera Max Number:
Remain Bandwidth: 108 /120 Mb

② Go to the live preview interface and then click  in the preview window of the IP camera to edit the IP camera's username and password.

Q8. The system cannot record, why?

a. Make sure the HDD was formatted prior to use.

b. The record schedule has not been set in customization mode. Please refer to [7.1.2](#)

Schedule Settings for details.

- c. Maybe HDD is full and thus the NVR is not able to record. Check HDD information from Disk Management and if required, please enable the recycle function (please see 7.1.3 Advanced Configuration for details).
- d. There is no disk but cameras in the disk group, so please add at least one disk to the group. Refer to 7.4.2 Storage Mode Configuration for details.
- e. The HDD could have gone bad. Please change another one.

Q9. Fail to access the NVR remotely through IE.

- a. Please make sure the IE version is IE8 or above.
- b. Please check whether the PC has enabled the firewall or installed the antivirus software. Please try to access the NVR again after you disable the firewall and stop the antivirus software.
- c. Allow & block list may have been set in Account and Authority setting. The PC of which the IP address is in the black list or out of the white list cannot access the NVR remotely.

Q10. ActiveX control cannot be downloaded. What can I do?

- a. IE browser blocks ActiveX control. Please do setup as per the steps mentioned below.

① Open IE browser. Click  → Internet Options.

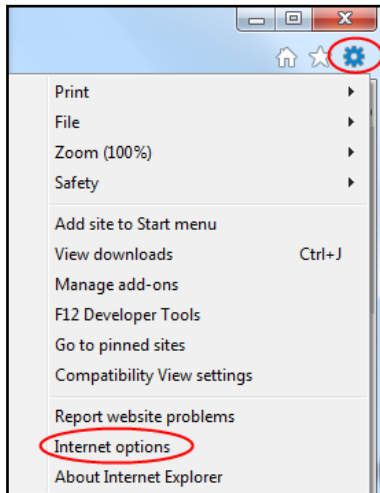

- ② Select Security → Custom Level. Refer to Fig 10-1.
 - ③ Enable all the sub options under “ActiveX controls and plug-ins”. Refer to Fig 10-2.
 - ④ Then click “OK” to finish setup.
- b. Other plug-ins or anti-virus may block ActiveX. Please disable or do the required settings.

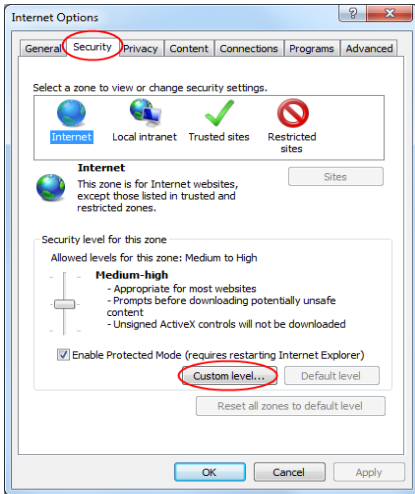

Fig 10-1

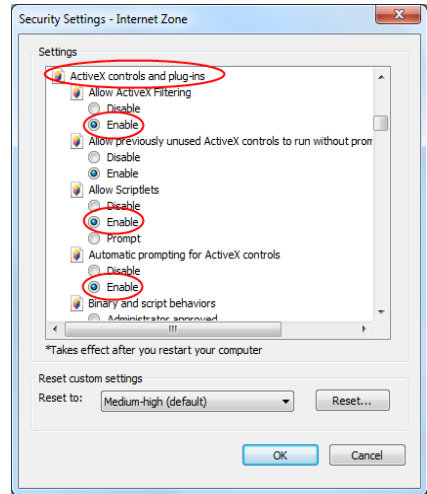



Fig 10-2

Q11. How to play the backup file?

- a. Recorded video backed up by NVR: insert the USB device in which the recorded video backup files is saved to the USB interface of the PC and then open the USB device path. The recorded video can be backed up in the private format and AVI format by NVR.
 - If you select the private format when backing up recorded video by NVR, a RPAS compression package will be backed up to the USB device automatically along with the recorded video data. Uncompress the “RPAS.zip” and then click “RPAS.exe” to set up RPAS. After the setup is completed, open RPAS player and then click “Open Folder” in the middle of the interface to select the record data. Refer to Fig 11-1.

Select camera in the resource tree on the left side of the interface to play the camera record. Click  on the tool bar under the camera image to enable audio. Refer to Fig 11-2.

Note: The record will not have audio output if you disable the audio when recording by NVR. Please see 7.1.1 Mode Configuration and 7.2 Encode Parameters Settings for details.

- If you select the AVI format when backing up recorded video by NVR, the recorded video backup data can be played by the video player which supports this format.
- b. Recorded video backed up through web. The recorded video can only be backed up with AVI format through web. The recorded video can be backed up to PC and played by the video player which supports this format.

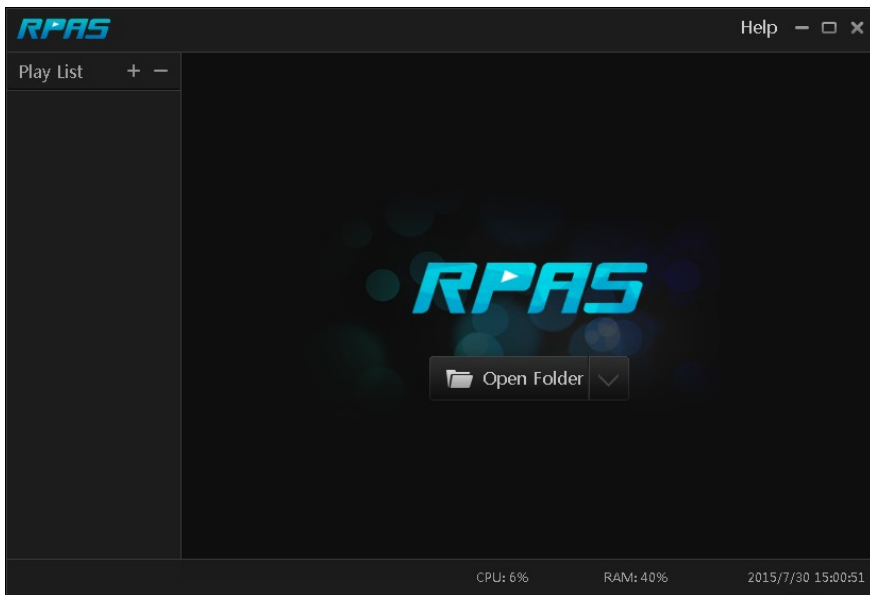

Fig 11-1

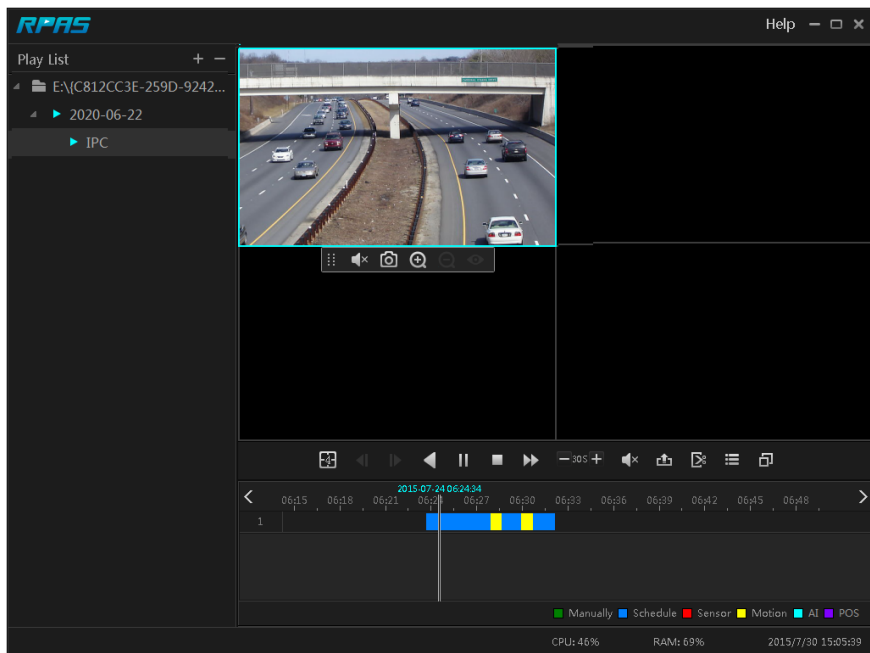

Fig 11-2

Q12. HTTPs service cannot work normally after directly installing the signed certificate.

- a. When importing the certificate, the private key is not attached to the certificate.
- b. When importing the certificate, the private key is attached to the certificate, but it is encrypted. At present, the NVR doesn't support the certificate with the encrypted private key.

Q13. You are prompted with the unsafe statements/tips when using HTTPs service.

- a. Please make sure your certificate is trusted.
- b. Make sure whether the Common Name (domain information) of the certificate matches with the domain name of the visiting website.
- c. Whether the certificate is within the period of validity.

Appendix B Calculate Recording Capacity

The recording capacity is mainly up to the record resolution, record stream and bitrate. Different image quality parameters decide different disk capacity occupation in equal times. The bigger the record resolution, record stream and record bitrate is, the more disk capacity is taken up in equal times. The calculation format of recording capacity is shown as below.

Recording Capacity(MB) = Bitrate(Kbps) ÷ 1024 ÷ 8 × 3600 × Recording hours per day × Record Storage Days × channel numbers

3600 means record for an hour(1TB=1024GB , 1GB=1024MB , 1MB=1024KB , 1Byte=8bit).

Record Bitrate (Kbps)	Used Space (MB/H)	Used Space (MB/D)
10240	4500	108000
8192	3600	86400
6144	2700	64800
4096	1800	43200
3072	1350	32400
2048	900	21600
1024	450	10800
768	337.5	8100
512	225	5400
384	168.75	4050
256	112.5	2700

The table below shows the recording capacity requirements for record storage in 30 days.

Record Bitrate (Kbps)	Recording Capacity(TB)					
	1CH	4CH	8CH	16CH	32CH	64CH
10240	3.09	12.36	24.72	49.44	98.88	197.76
8192	2.48	9.89	19.78	39.56	79.11	158.21
6144	1.86	7.42	14.84	29.67	59.33	118.66
4096	1.24	4.95	9.89	19.78	39.56	79.11
3072	0.93	3.71	7.42	14.84	29.67	59.33
2048	0.62	2.48	4.95	9.89	19.78	39.56
1024	0.31	1.24	2.48	4.95	9.89	19.78
768	0.24	0.93	1.86	3.71	7.42	14.84
512	0.16	0.62	1.24	2.48	4.95	9.89
384	0.12	0.47	0.93	1.86	3.71	7.42
256	0.08	0.31	0.62	1.24	2.48	4.95

For instance, there is a 32CH NVR recording 24 hours per day and the record stores for 30 days. The NVR adopts dual stream recording. The main stream is 4096Kbps and the sub stream is 1024Kbps, then the total recording capacity is 49.45TB (39.56TB + 9.89TB). Considering the format loss of the disk is about 10%, the required disk capacity will be 55TB (49.45TB ÷ (1-10%)).

Appendix C Compatible Device List

Compatible HDD list

Brand and Series		Capacity
Seagate	Barracuda Series	500GB /1TB /2TB /3TB
	SV35 Series (recommended)	1TB /2TB /3TB
	Surveillance HDD Series (recommended)	1TB /2TB /3TB /4TB /6TB/8TB/10TB
Western Digital	Blue Series	500GB /1TB
	Green Series	2TB /3TB /4TB
	Purple Series (recommended)	1TB /2TB /3TB /4TB /6TB/8TB/10TB

Compatible USB mobile device

Brand	Capacity
SSK	2GB
Netac	4GB
Kingston	2GB/8GB/16GB/32GB
Aigo	2GB
Smatter vider	1GB
SanDisk	4GB/8GB/16GB/32GB

Appendix D Communication Port List

Port	Protocol(TCP/UDP)	Descriptions
80	TCP	Description: HTTP communication port. It is opened by default and used to access the WEB client. Authentication: Username and password Encryption: NO
443	TCP	Description: HTTPS communication port. It is opened by default and used to access the WEB client. Authentication: Username and password Encryption: TLS
554	TCP	Description: RTSP communication port. It is closed by default. After enabling RTSP function, this port will be opened and used to transfer audio and video stream. Authentication: Username and password (Digest) Encryption: NO
6036	TCP	Description: Private communication port. It is opened by default and used to transfer audio and video stream. Authentication: Username and password (Digest) Encryption: AES
9036	TCP	Description: This port is opened by default which is mainly used to receive the information sent by the POS terminal or printer. The information will be overlaid on the image of the IPC you have configured in previewing or recording mode. Authentication: NO Encryption: NO
41952	TCP	Description: This port is opened by default which is mainly used to receive the request sent by other UPnP devices and communicate with other UPnP devices. Authentication: NO Encryption: NO
41953	TCP	Description: This port is closed by default. After the UPnP function is enabled, this port is enabled too. It is mainly used to receive the request sent by other UPnP devices and communicate with other UPnP devices. Authentication: NO Encryption: NO
1900	UDP	Description: This port is opened by default which is used to enable, find and run SSDP. Additionally, it is also used to listen to and receive the multicast packets from other online UPnP devices. Authentication: NO Encryption: NO

Appendix E Personal Data Collection Description

There are five functions concerning the personal data collection under the network modules of the device, including PPPoE, DDNS, E-mail, 802.1x and FTP. In the device, these functions are used by the client-end of the device to communicate with the server of the customer's company (or service supplier). As the client-end, our device needs to keep the authentication credentials (username and password) used to connect the server. These credentials can be configured through the Web client of the device and then sent to the device. The process of the data transmission and storage are as follows.

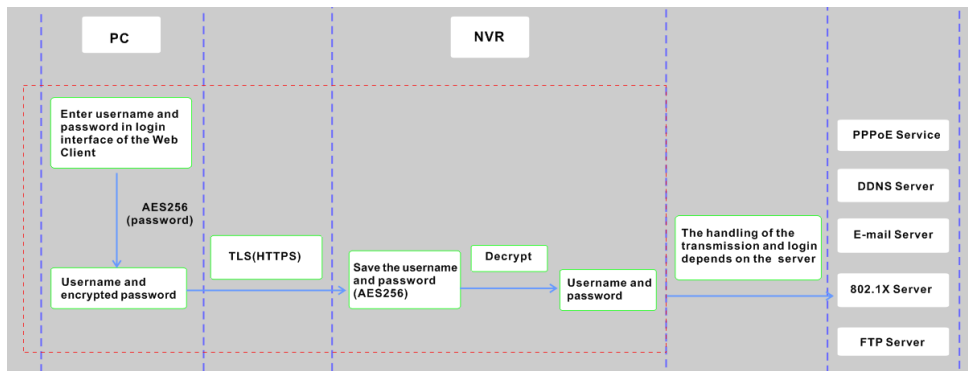

Function	Personal Data Type	Transmission Type	Storage Type	Authentication
PPPoE	Username, Password	TLS+AES256(password)	Password : AES256	Username/Password
DDNS	Username, Password	TLS+AES256(password)	Password : AES256	Username/Password
E-mail	Username, Password, E-mail address	TLS+AES256(password)	Password : AES256 The E-mail address will be desensitized before it is displayed on the page.	Username/Password
802.1x	Username, Password	TLS+AES256(password)	Password : AES256	Username/Password
FTP	Username, Password	TLS+AES256(password)	Password : AES256	Username/Password

Statement:

Except for service authentication when communicating with the server, we will never share these personal data stored on the device to the third-party or use them by ourselves without the client's authorization.

The log will record the operator's operation steps and change records, but will not contain any information about the collected personal data.

Appendix F Default Account List

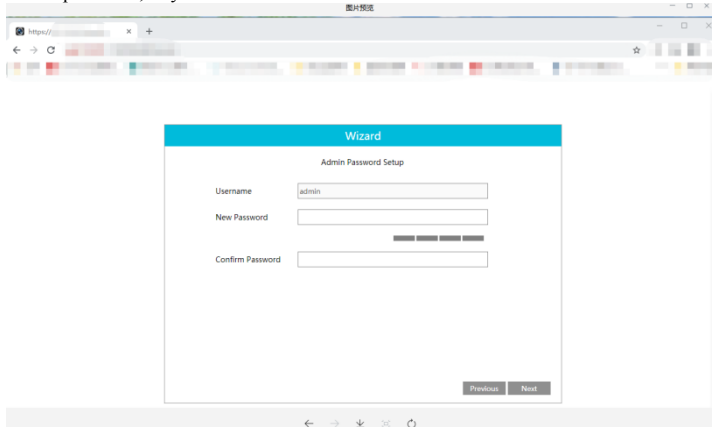
Username	Default Password	Descriptions
admin	NO	<p>Purpose : log onto the device and its clients</p> <p>Description : When you log in for the first time, a wizard will be displayed. You must set the password, or you cannot access the device.</p> 
root	NO	<p>Purpose : Test via serial port</p> <p>Description : The default password of “root” is null. It doesn’t mean you can log in the device without password. You must set the password of “admin” in the above-mentioned interface first. Then you can log in by using “root”.</p>

Statement :

Remote testing/debugging doesn't support for the device (Telnet/SSH unavailable). When an error occurs, the customer needs to send the device back to our company and tell us the password of “admin” used to log in the device and web client. Then the corresponding technician of our company will log in the serial port to find the problem. Without the customer's identity verification information and the customer's authentication, we cannot log in and do not have permission to log into the device.

Appendix G Command List

Command Type	Function	Command Contents
Operating Command	HiLinux Operating System Command	add-shell addgroup adduser arp ash awk basename blkid blockdev btools busybox cat chat chmod chpst cmp cp cut date dd delgroup deluser depmod devmem df diff dmesg dnsdomainname dos2unix du echo ed egrep eject env envdir envuidgid expr fbset fgrep find free fsck.vfat fsync getty grep groups halt head hexdump hiddrs himc himd himd.l himm hostname hwclock i2c_read i2c_write id ifconfig ifstat init insmod iostat ip ipaddr iplink iproute iprule iptables iptunnel kill killall killall5 ln login logname ls lsmode lsof lspci lsub lzcat lzma md5sum mdev mkdir mkfifo mknod modinfo modprobe mount mountpoint mv netstat nice passwd pidof ping ping6 pmap poweroff pppd pppoe printf ps pstree pwd readlink reboot remove-shell renice restoreCFG_N9000.sh rm rmdir rmmode route sed setsid setuidgid sh shutdown_os.sh sleep softlimit stat stty sync tail tar test time top touch tty ubiattach ubidetach udevadm udevd udhpc amount uname unix2dos unlzma uptime usleep vconfig vi watch wc xargs yes

